

Wireless World

RADIO, TELEVISION
AND ELECTRONICS

42nd YEAR OF PUBLICATION

Managing Editor: HUGH S. POCOCK, M.I.E.E.

Editor: H. F. SMITH

MARCH 1953

In This Issue

EDITORIAL COMMENT	101
D.C. RESTORATION IN TELEVISION. By <i>W. T. Cocking</i> ..	102
WENVOE SERVICE AREA	107
DESIGNING A TAPE RECORDER—1. By <i>J. M. Carter</i> ..	108
NEW HIGH-GRADE CONDENSER MICROPHONES—2. By <i>F. W. O. Bauch</i>	111
SHARED TELEVISION CHANNELS. By <i>F. R. W. Strafford</i> ..	114
LETTERS TO THE EDITOR	117
WORLD OF WIRELESS	119
SYNTHETIC RADAR TRAINER	123
TRANSISTORS—2. By <i>Thomas Roddam</i>	125
OSCILLATOR/FILTER UNIT By <i>A. Q. Morton</i>	129
ATTENUATORS. By “ <i>Cathode Ray</i> ”	131
TIME BY TELEARCHICS	136
FLYWHEEL SYNCHRONIZATION. By <i>B. T. Gilling</i>	137
BOOKS RECEIVED	140
CALIBRATING V.H.F. OSCILLATORS. By <i>M. C. Matthews</i> ..	141
TELEVISION SOCIETY'S EXHIBITION	142
MANUFACTURERS' PRODUCTS	143
RANDOM RADIATIONS. By “ <i>Diallist</i> ”	144
UNBIASED. By “ <i>Free Grid</i> ”	146

PUBLISHED MONTHLY (last Tuesday of preceding month) by ILIFFE & SONS LTD., Dorset House, Stamford Street, London, S.E.1. Telephone: Waterloo 3333 (60 lines). Telegrams: “Ethaworld, Sedist, London.” Annual Subscription: Home and Overseas, £1 7s. 0d. U.S.A. \$4.50. Canada \$4.00. BRANCH OFFICES: Birmingham: King Edward House, New Street, 2. Coventry: 8-10, Corporation Street. Glasgow: 26b, Renfield Street, C.2. Manchester: 260, Deansgate, 8.

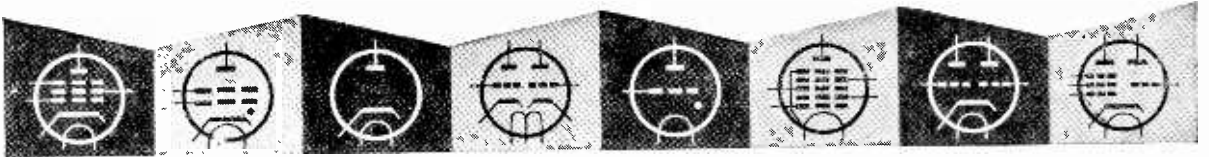

VALVES, TUBES & CIRCUITS

3. A PUSH-PULL AUDIO OUTPUT STAGE EMPLOYING TWO ECL80 TRIODE-PENTODES (contd.)

The triode section of one valve (V1A) functions as a voltage amplifier while the triode of the other valve (V2A) is used as a phase inverter. As this triode shares the same cathode as one of the output pentodes it is not possible to use the conventional type of cathode-coupled phase inverter. This has been overcome by connecting the triode as an anode follower.

In the arrangement shown in Fig. 1, the triode section V1A drives the pentode V1B in the same envelope, and V2A drives V2B. This mode of operation should not show any tendency to high frequency oscillation due to the capacitance between the pentode anode and triode grid being in the same bulb. An alternative and more stable arrangement is to drive V2B from V1A and V2A from V1B.

The cathodes of all four sections are connected together and returned to earth through a common impedance. If this impedance is too large it is possible for low frequency oscillation to occur. With a coupling capacitance, C1, of 0.01 μ F, the cathode bypass capacitance must be greater than 150 μ F to prevent oscillation. To allow an adequate margin of safety, a dry electrolytic capacitor of 250 μ F, 12V working, is recommended. The following table gives the approximate overall performance of the amplifier, using the components given in Fig. 1.

TYPICAL OVERALL PERFORMANCE DATA

V _b	170	...	200	V
R _{a-a}	15	...	15	k Ω
* I _{k(o)}	35	...	42	mA
* I _{k (max. sig.)}	38	...	46	mA
V _{in (r.m.s.)}	0.5	...	0.6	V
P _{out}	2.0	...	3.0	W
D _{tot}	3.0	...	3.5	%

* For two valves.

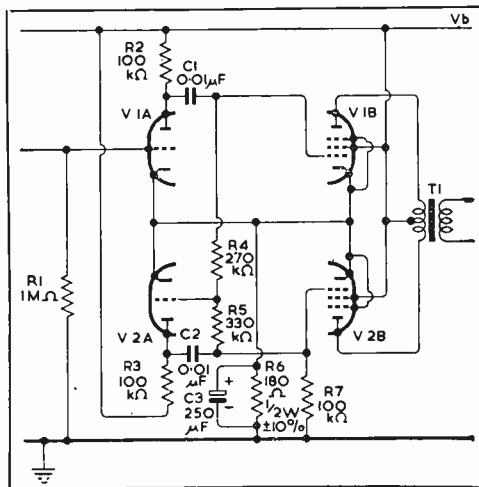

Fig. 1. Circuit diagram of amplifier



Reprints of this advertisement together with additional data may be obtained free of charge from the address below.

MULLARD LTD., Technical Publications Department, Century House, Shaftesbury Avenue, W.C.2.

Wireless World

MARCH 1953

VOL. LIX No. 3

Ethics of Home Recording

WRITING in our January issue with the diffidence that is proper in laymen who touch upon legal matters, we said there was no precedent for thinking that the recording of broadcasts for subsequent play-back in the domestic circle would amount to an infringement of copyright. We also argued that nobody suffers any loss through the home recordist's action. On p. 117 of this issue we print a comment on these views from Dr. T. E. Allibone, F.R.S., who was, we understand, the only scientifically qualified member of the Committee which advised the Government on copyright matters.

Much to our regret, Dr. Allibone does not find himself in agreement with either our law or our ethics. The legal point we leave to others to decide. As to the ethics of the matter, the recordist is not stealing anything; a part of his licence fee is paid to the copyright holders. To us, recording is no more than a delayed method of radio reception, which enables the recordist to hear what he wants at his own convenience.

Television Boosters

AS a matter of national economics, the cost of television transmitters is, with a broadcasting system like our present one, quite insignificant in comparison with that of the complementary receivers. This idea seems recently to have been accepted by the Government, which now gives it, more or less, as a reason why completion of the B.B.C.'s system must be deferred. But the principle seems to be accepted that, by way of compromise, it may be permissible to reinforce the signal in poorly served areas by means of low-powered "booster" stations. The argument is, apparently, that the stations themselves do not cost much, and—rather less convincing—that their operation will not greatly increase the demand for new receivers in the area served.

These boosters may be of two kinds. The first, which reinforces the signal of its parent station without frequency changing, might have a limited application in a country where parts of the terrain are

extremely rugged. In Great Britain one can hardly envisage the use of that method, and it is safe to assume that a change of frequency will almost always be necessary. The two systems are being discussed* in the United States, where doubtless both will have their uses. There it is proposed that the term "booster" should be restricted to stations without frequency changing; the others should be called "satellites." That arbitrary nomenclature is likely to be confusing here, where at present all the B.B.C. stations are in fact satellites to a central source of programmes.

If there is any real objection to the term "booster," we might play for safety and adopt the word "repeater." "Relay," having other connotations, is ruled out. Whatever we call them, the stations may be defined as receiving their modulating signals by direct radio reception from a parent transmitter, in contra-distinction to those fed through a radio relay chain or r.f. cable. *Wireless World* hopes to publish some more detailed information on the possibilities of this economical method of signal reinforcement, which, we understand, has shown very promising results during tests.

Geared to Greenwich

ELSEWHERE in this issue we publish a note on proposed changes in the standard frequency transmissions sponsored by the National Physical Laboratory. When these changes were first mooted, we had visions of something much more spectacular; there was, in fact, a suggestion that a continuous stream of 1-c/s impulses were to be emitted.

Though this idea seems to have had an unsubstantial foundation, it is not entirely profitless to speculate on its possibilities. A continuous transmission of one-second pulses would make practicable a truly radio-driven clock—as opposed to radio-controlled. Time-keeping accuracy even up to the standard needed for astronomical purposes would be available to anyone who cared to set up a radio receiver arranged to actuate a simple and cheap clock mechanism.

* *Electronics*, January, 1953

D.C. Restoration in Television

Characteristics of the Circuit

By W. T. COCKING, M.I.E.E.

IT has now become almost the standard practice in television receivers to use as a sync separator a single r.f. pentode which is fed with the composite video signal through an RC coupling. This same signal is also fed to the cathode of the c.r. tube and is consequently of such polarity that the sync pulses are positive-going and the picture signal is negative-going. The main function of the sync-separator stage is to remove as completely as possible the picture content of the composite input signal and to provide an output of synchronizing pulses which is independent of the nature of the picture and which is also independent of the actual amplitude of the signal within certain limits. A secondary function is that the stage should remove as much noise as possible from the sync pulses.

The video stage with its coupling to the c.r. tube commonly has the form shown in Fig. 1. The coupling resistor is R and the inductance L is inserted to compensate for the effects of the unwanted stray

capacitance C . It does this reasonably well over the range of video frequencies and over this range the impedance of the LCR network is substantially constant and of value R . At the higher end of the band the impedance does depart somewhat from this, it is true, but the effect is not important for present purposes.

The potential-divider R_1, R_2 is included mainly to reduce the mean cathode potential of the c.r. tube so that its heater-cathode voltage is not excessive. The capacitance of C_1 is made large enough for it to be a virtual short circuit to R_1 for all the frequencies involved in the video signal. Commonly $R_1 = R_2 = 100 \text{ k}\Omega$, $C_1 = 2-8 \mu\text{F}$, and R is about $3 \text{ k}\Omega$. The peak-to-peak signal amplitude is of the order of 40 V . For our present purposes we can replace the video stage of Fig. 1 (a) by the simple equivalent circuit (b) of a generator E , which provides a signal the same as the output of the real stage, in series with a resistance R , which is equal to the output impedance of the real stage.

The sync separator stage itself has the form of Fig. 2 in which R_1, R_2 and C_1 are commonly $10 \text{ k}\Omega$, $1 \text{ M}\Omega$ and $0.1 \mu\text{F}$ respectively. In the transmission the tip of a sync pulse corresponds to zero carrier level and in the detector output it corresponds to the voltage (if any) which exists across the diode load with no signal. Similarly, if the video stage functions perfectly the tips of the sync pulses always occur at the same fixed voltage level in its output and all changes in the signal occur with reference to this level. Thus, in Fig. 1 (a), if the no-signal cathode potential of the c.r. tube is 100 V above earth and the output is 40 V p-p, black level will always correspond to some fixed level around 90 V and white to 60 V .

Passing the signal through an RC coupling removes its d.c. component and after the coupling it has no fixed level of reference. It is not simply that the fixed 100-V level of the above example is removed but that the signal excursions take place about any fixed level in a variable way so that black, white and the tips of the pulses no longer occur at fixed levels.

The way in which this occurs is very easily seen. Consider the simple circuit of Fig. 3. Initially let E be zero and C uncharged so that the whole circuit is quiescent. Then let the applied voltage change instantaneously from zero to $-E$, so that the potential of the upper terminal of the generator in Fig. 3 jumps from zero to $-E$ volts. The capacitor C cannot charge instantly and the only immediate result is for the voltage to drive a current of magnitude

$$i = \frac{E}{R_1 + R_2}$$

round the circuit. Electrons flow round the circuit in the direction shown by the arrow. The voltage

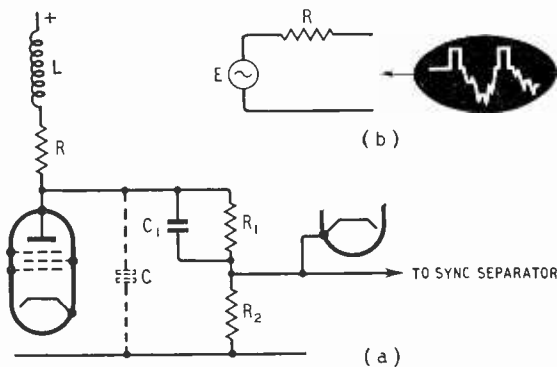

Fig. 1. Typical output circuit of a video stage (a) and its equivalent (b)

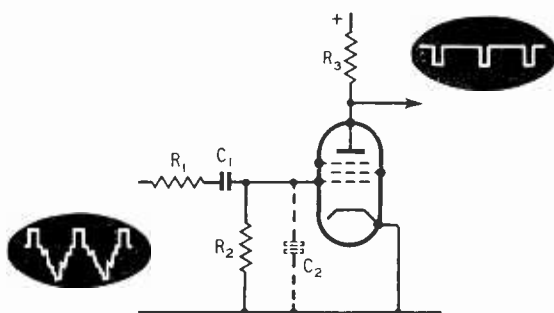

Fig. 2. Basic sync separator stage.

which instantly appears across R_2 is $iR_2 = v$ which is, of course,

$$v = E \frac{R_2}{R_1 + R_2}$$

The electrons flowing into the left-hand side and out of the right-hand side of C gradually charge it so that a potential difference appears across it with the polarity indicated. This opposes the applied voltage and reduces the current and so the output voltage v falls too. If the input voltage is not maintained for very long then the current and output voltage will not have altered very much by the time it returns to zero. The current will, in fact, have changed only from i to $i(1 - \tau_1/T)$; that is, by the amount $i\tau_1/T$, where τ_1 is the time for which the input is maintained constant at E volts and $T = C(R_1 + R_2)$ is the time constant of the circuit. The output v falls proportionately, for it is always iR_2 .

In Fig. 4 (a) the initial change of voltage is shown by AB and the maintained voltage by BC. In (b) is shown the resulting current i ; the initial change is again denoted by AB and, greatly exaggerated, the changing current during τ_1 by BC. When the input returns to zero CD, (a), the capacitor C is left with a charge. As long as E is zero, C then discharges through R_1 and R_2 . The change of current corresponding to the voltage change CD of (a) is shown at CD in Fig. 4 (b) and equals the initial change AB.

If E is maintained zero for a time τ_2 much shorter than τ_1 , C must discharge proportionately less than it charged during τ_1 . The change of current during τ_2 is, therefore, very small. When the input changes to $-E$ again, therefore, along FG, the current at G is only very slightly different from what it was at C . With successive cycles there is a gradual drift in the extreme values of current until an equilibrium condition is reached in which the charge gained by C during one period τ_1 exactly equals that lost by it during one period τ_2 . When this occurs the shaded areas in Fig. 4 (b) are equal.

In the steady-state, when this equilibrium has been reached, a black television picture has for one line the waveform shown in Fig. 5 (a), the shaded areas being equal. For a white line the waveform is like (b), the shaded areas again being equal. It will be seen that both the tips of the sync pulses and black levels occur at very different voltages with reference to the zero level in the two cases. Since the limiter, which must be used to remove the picture signal, operates at a fixed level it cannot function on such a waveform.

In order to keep the sync pulses at a constant level, as they are in the input, it is necessary to discharge C (or alternatively to charge it to a fixed constant value) on every pulse. If in Fig. 3 there were a switch across C which closed every time the input became zero for the tip of a sync pulse, C would at once discharge to its initial zero level. Every output cycle would then be precisely like the input cycle, save for the small drop due to the charging of C during the period τ_1 .

Unfortunately an ideal switch cannot be used and in d.c. restoration the practical equivalent is a diode of very appreciable resistance. Also it cannot usually be connected directly across C because different mean voltage levels at input and output are usually wanted. The diode is, therefore, connected across R_2 . This has the effect of giving the circuit two time constants. One when the diode is conducting and another when it is not.

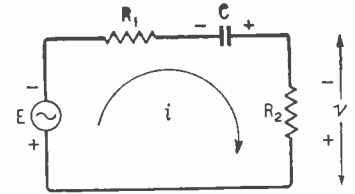

Fig. 3. Circuit arrangement of single RC coupling.

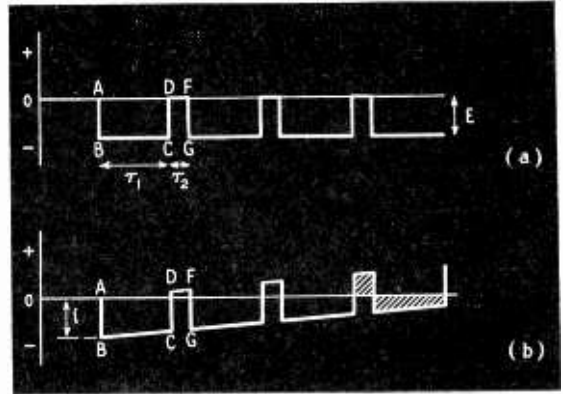

Fig. 4. Input waveform corresponding to line sync pulses (a) and the output of an RC coupling (b); the latter is also the current waveform since $v = iR_2$.

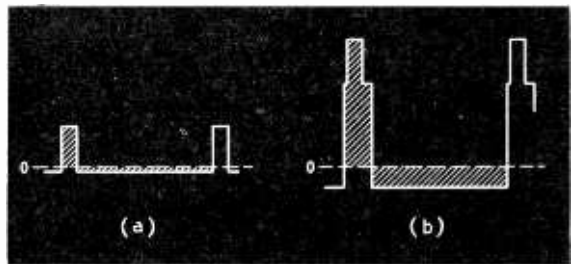

Fig. 5. Waveforms of one line in the steady-state during an all-black picture (a) and an all-white (b).

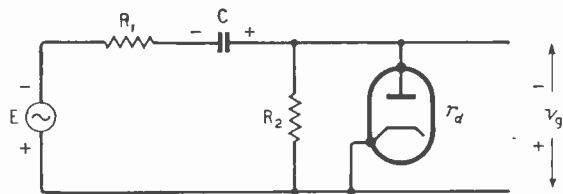

Fig. 6. The diode added to the circuit of Fig. 3 provides d.c. restoration.

The circuit becomes as shown in Fig. 6. For the moment we will idealize the diode and say that it does not conduct at all when its anode is negative to its cathode and it conducts with a constant resistance r_d when its anode is positive.

Starting with C uncharged the first part of the cycle ABC in Fig. 4 is precisely the same as before because the diode is non-conducting and does nothing. When the input changes to D [Fig. 4(a)], however, the diode conducts and C discharges through R_1 and r_d for the period τ_2 (R_2 being so high in comparison

with r_d that it can be neglected). Because τ_2 is much shorter than τ_1 , the discharge of C in this interval was previously very small. Now, however, the time constant $T_d = C(R_1 + r_d)$ of discharge is much smaller than the time constant $T = C(R_1 + R_2)$ of charge. If T_d can be made so small that C can be almost completely discharged in the period τ_2 , then the initial conditions on the next change of voltage FG are negligibly different from those on the first.

In a practical case R_2 may be 1 M Ω and $C = 0.1 \mu\text{F}$; if R_2 is much larger than R_1 the charging time constant is $T = 0.1$ second and the period τ_1 is nearly 90 μsec . During this time C is charged to $\tau_1/T = 90/100,000 \approx 1/1,000$ of the applied voltage. The discharge during τ_2 is exponential and is 99% complete if $\tau_2/T_d = 4.5$; now $\tau_2 = 10 \mu\text{sec}$, so T_d should be $10/4.5$, say 2 μsec . The discharge time constant should thus be $1/50,000$ of the charging time constant. As C is the same for both this means $R_2 = 50,000 (R_1 + r_d)$ and if $R_2 = 1 \text{ M}\Omega$, we must have $R_1 + r_d = 20 \Omega$.

It is quite impossible even to approach such a figure. The value of R_1 can rarely be less than 3 k Ω while r_d is of the same order of magnitude. In practice it may well be difficult to make $R_1 + r_d$ less than 10 k Ω . If R_2 were made 50,000 times this it would be 500 M Ω , which is equally impracticable.

It is not possible, therefore, in this way to discharge C every cycle and so it is not possible to achieve a fixed mean voltage across it for every cycle. All that can be done with d.c. restoration is to reduce in magnitude the changes which occur in the single RC coupling. They remain of the same nature but are of much smaller magnitude. A ratio of charge to discharge time constants of about 500 : 1 can be achieved in practice and is usually adequate. An appreciable change of the absolute black levels and sync pulse levels then occurs but as long as the change is small compared with the pulse amplitude itself it has little effect on subsequent limiting and that is the really important thing.

This is illustrated in Fig. 7 which shows, at (a) and (b) the output voltage waveforms with d.c. restoration. On an all-white signal (b) the sync-pulse tips are a little more positive and black level is a little less negative than with the all-black signal (a). When the picture changes from one to the other there is, of course, a slow drift from one condition to the other. If a white signal follows a black one, for instance, it starts off with all-black conditions with sync pulses and black level as in (a) and gradually drifts to (b).

In practice, it is important to keep the change of black level small and it is desirable to be able to calculate what it is. This calculation is easy enough

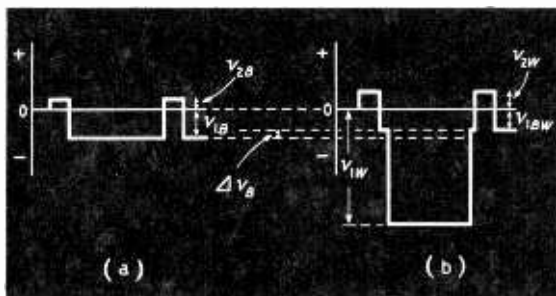

Fig. 7. Waveforms comparable to those of Fig. 5 but with d.c. restoration.

as long as the diode is considered as an open-circuit on the one hand and as a constant resistance r_d on the other. The changing voltage on C when this component has only a finite capacitance can be taken into account.

A real diode, however, has a resistance which is very far from constant; it has a resistance which changes with voltage from infinity to a low value of a few hundred ohms only. The diode, moreover, passes current until the anode voltage is more than about 1.3 V negative to cathode.

Because of this an exact analysis is impracticably difficult, and it is necessary to find an approximate method which will give reasonably accurate results. An actual diode characteristic is of the form sketched in Fig. 8. Now with a particular signal level, the tips of the sync pulses for an all-black signal will drive the diode to some point v_{2B} on its characteristic at which the current is i_{2B} . On an all-white signal the working point will change to v_{2W} at which the current is i_{2W} .

If a straight line AB is drawn through these two points it cuts the zero current axis at some voltage $-e_d$ and the line represents a resistance

$$r_d = \frac{v_{2W} - v_{2B}}{i_{2W} - i_{2B}}$$

If we represent the diode by a resistance r_d and a battery $-e_d$ in series, as in Fig. 9, then the representation is exact as long as we confine operation to the two voltages. If we depart from these voltages it becomes approximate, but if the departures are small the approximation is obviously a good one.

It is possible, therefore, to use the equivalent circuit of Fig. 9 to obtain a general solution for the change of black level between all-black and all-white pictures and the solution will be exact as long as C_1 is large enough. The determination of r_d and e_d is dealt with in Appendix 1 on the assumption that the characteristic of the diode can be represented by the exponential expression of equation (1.1). This law holds only for small currents and is really an approximate relation. It is treated in some detail in "Waveforms," M.I.T. Radiation Laboratory Series, Vol. 19, p. 63 (McGraw-Hill). The form of the characteristic is a straight line when plotted on semi-log paper and different diodes vary from one another only in the position of the line, not in its slope.

In Appendix 2 the performance of the d.c. restoring circuit is analysed. It needs little explanation here, for it is based on the requirement discussed earlier that the charge flowing into C during an inter-pulse period must equal that flowing out during a sync pulse. Equations (2.13) and (2.16) express one of the most important factors of a d.c. restorer, the change of black level between an all-white picture and an all-black one. With a perfect restorer the change would be zero.

These two equations can be combined. Doing this and also introducing values appropriate to the British television system we get, with slight approximation,

$$\Delta v_B = 0.83 \frac{E_1 (R + R_1) + 0.014 R_2}{R + R_1 + R_2/10}$$

where, it must be emphasized, E_1 is the amplitude of the picture part of the signal and Δv_B is the change of black level between an all-white picture and an all-black. The accuracy is sufficient for most purposes.

In practice, R is usually about 3 k Ω and R_1 is around 10 k Ω , while R_2 is often 1 M Ω . With a picture

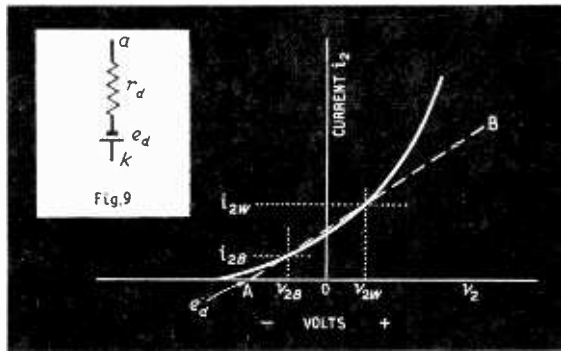

Fig. 8. General form of diode characteristic. If operation is confined to two distinct voltages v_{2B} and v_{2W} , it can be represented by a straight line AB. Fig. 9. (Inset) Equivalent circuit of diode for the conditions of Fig. 8.

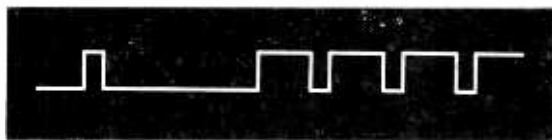

Fig. 10. Sync waveform during the frame pulses.

signal of 30 V p-p we find $\Delta v_B = 2.96$ V which, if the signal is reduced to 15 V, becomes 1.54 V. Since the sync pulse amplitude is about 5-10 V the variations of black level are quite appreciable fractions of it.

If R_1 is omitted there is a considerable improvement. In a 30-V signal Δv_B then becomes 0.85 V. If, as well, R_2 is increased to 4.7 M Ω the change of black level drops to 0.28 V. It is clearly important to keep R_2 as large as possible and $R + R_1$ as small as possible.

In the ordinary way $R + R_1$ cannot be less than about 3 k Ω , for this is the output impedance of the video stage. One could use an intermediate cathode-follower stage, it is true, and obtain an impedance as low as 100 Ω , but the expense of this would rarely be justifiable. In normal commercial receiver practice d.c. restoration is used only at the sync separator and the grid-cathode path of a pentode serves as the d.c. restoring diode while the other electrodes provide the limiting action. One limit is set by anode-current cut-off, and removes the picture content and the pulse variations near black level; the other limit is set by anode circuit "bottoming" and removes the variations in the tips of the pulses.

The resistance R_1 is often included and serves a double purpose. First, it largely removes the effect of the input capacitance of the sync separator, C_2 , of Fig. 2, from the video stage, thus permitting R to be somewhat larger than would otherwise be the case. For this to be effective, R_1 must be several times R in value. Secondly, R_1 in conjunction with C_2 gives some slight integrating action. This sounds a bad thing in that it

increases the rise time of the edges of the pulses. However, it is found that it reduces the effect of interference quite considerably. The effect depends on the type of interference, but in some cases the improvement in the synchronizing under noisy conditions is quite spectacular.

It appears, therefore, that the designer has most freedom in his choice of value for R_2 . This is more illusory than real, however, for there are severe limits to its maximum value set by surface and other leakage. Many designers feel it unwise to use any resistance above 2 M Ω in value because of the danger of the effective value being a very variable quantity through surface leakage, the input impedance of valves and the leakage resistance of capacitors. Some designers place the limit lower and dislike anything above 1 M Ω . Others feel that they can control leakage better, perhaps, and will use values up to 5 M Ω ; a few, a very few, will use values up to 10 M Ω .

Everything depends on the quality of the components used and upon the operating conditions. In the writer's view, 2 M Ω is a desirable maximum for the usual television conditions, but there is no doubt that one could go higher without serious trouble.

No account has so far been taken of the change of waveform which occurs during the frame fly-back interval. The waveform changes in the way shown in Fig. 10. On the first frame pulse the diode is conductive for 40 μ sec instead of the 10- μ sec of a line pulse; C_1 , therefore, discharges more. Then during the following 10- μ sec interval C_1 can charge less than on the 90- μ sec intervals between line pulses. As a result there is a gradual shift of the waveform in a negative direction.

If we take black level on an all-black picture as a reference level, the black level during the frame sync pulses is more negative than this and the black level during an all-white picture is less negative. There are only some eight frame pulses, of course, and this is rather few for the steady-state to be reached; the magnitude of the shift is, therefore, likely to be in practice less than the steady-state shift. The maximum possible shift, however, is for the tops of the pulses to come very nearly to the grid-current cut-off point. This occurs if C_1 discharges completely during the pulses, which is unlikely, and then the pulse level is at the intersection of the grid-current curve with the load line for R_2 .

The tips of the sync pulses will thus vary from a most-negative level during the frame sync pulses which is close to the grid-current cut-off point and may be

TABLE 1.

	$E_1 = 15$ V		$E_1 = 30$ V		Equation
	$R_1 = 0$	$R_1 = 10$ k Ω	$R_1 = 0$	$R_1 = 10$ k Ω	
r_d	2.175 k Ω	2.26 k Ω	1.085 k Ω	1.13 k Ω	2.15
x	48.3	16.4	61	17.7	
v_{1B}	- 4.9 V	- 4.71 V	- 9.85 V	- 9.48 V	2.10
v_{1WB}	- 4.62 V	- 3.9 V	- 9.4 V	- 8 V	2.12
Δv_B	0.282 V	0.8 V	0.446 V	1.48 V	2.13
$E - V_{cB} + e_d$	0.1015 V	0.287 V	0.162 V	0.532 V	2.4
i_{2B}	19.6 μ A	18.8 μ A	39.8 μ A	37.8 μ A	2.1
v_{2B}	- 0.215 V	- 0.212 V	- 0.145 V	- 0.15 V	1.4
e_d	- 0.2575V	- 0.2545 V	- 0.577 V	- 0.578 V	1.3
v_{2W}	0.4195 V	0.4165 V	0.739 V	0.74 V	2.9
v_{1W}	- 19.62 V	- 18.9 V	- 39.4 V	- 38 V	2.11

For $R = 3$ k Ω , $R_2 = 2.2$ M Ω , $E_1/e_1 = 3$, $\tau_2/\tau_1 = 0.1125$, $\tau_3/\tau_1 = 0.927$, $i_0 = 200$ μ A.

taken as about -1.3 V to a most-positive (least negative) level during an all-white picture. This depends on the signal amplitude and the diode characteristics but is usually around -0.5 V to zero volts. If the following limiter is arranged not to respond to an input more positive than -1.5 V all the variations of the tips of the pulses should be cut-off under all conditions.

A second, more negative, limiting level is needed to remove the picture content. This must obviously be more positive than the black-level on an all-white picture. Table 1 shows the voltages calculated from the equations of the Appendices. In a 30-V picture signal, the black level is -8 V with $R_1 = 10$ k Ω and $R_2 = 2.2$ M Ω . One must, however, allow a considerable latitude for contrast adjustment and, ideally, the synchronizing should be unaffected even when the signal falls to such a level that the picture is quite washy. With a 15-V signal, the black level changes to -3.9 V and one could arrange the cut-off point of the limiter at, say, -3.5 V. On this basis the limiter will be designed to pass between the limits of -1.5 V and -3.5 V, but not to respond to signals more positive or more negative than these.

So far the capacitor C_1 has been assumed to be infinitely large. For this to be approximately true it is necessary for C_1 to be large enough for its charge to change negligibly during any one period of the waveform. If we take a 1% change as permissible we have $t/T = 0.01$ when t is the time and T is time constant. During a line interval t is 90 μ sec and $T = C_1 R_2$. The general formula becomes $C = 100t/R$ in pF, μ sec and M Ω .

For the line interval $C = 100 \times 90/2.2 = 4,100$ pF = 0.0041 μ F with $R_2 = 2.2$ M Ω . For the line sync pulse $t = 10$ μ sec and the resistance is $R + R_1 + r_d$, say 14 k Ω , so $C = 100 \times 10/0.014 = 71,500$ pF = 0.0715 μ F. During the frame pulse intervals of 10 μ sec the resistance is 2.2 M Ω and C need be only $0.0041/9 = 0.00045$ μ F, but during the frame pulses themselves, 40 μ sec, when the resistance is 14 k Ω , C should be $0.0715 \times 4 = 0.286$ μ F. The conditions are thus substantially met if C_1 is 0.3 μ F. In practice C_1 is not usually as large as that and is rarely more than 0.1 μ F. This meets the requirements except during the frame pulses, but even then the departure from them is quite small.

APPENDIX 1.

The diode characteristic is assumed to be

$$i_2 = i_0 e^{11v_2} \dots \dots \dots (1.1)$$

where i_0 is the diode current at zero voltage.

On all-black and all-white signals respectively the diode is driven during the sync pulses to the voltages v_{2B} and v_{2W} , Fig. 7, for which the currents are i_{2B} and i_{2W} . For these two voltages only the characteristic is that of a resistance r_d in series with a battery e_d as shown in Fig. 9. In Fig. 8 is shown how the line representing the resistance cuts the diode curve at the two operating points. The resistance is

$$r_d = \frac{v_{2W} - v_{2B}}{i_{2W} - i_{2B}} \dots \dots \dots (1.2)$$

and the battery is

$$e_d = i_{2B} r_d - v_{2B} \dots \dots \dots (1.3)$$

From (1.1)

$$v_{2W} = 0.09 \log_e i_2 / i_0 \dots \dots \dots (1.4)$$

$$\therefore r_d = \frac{0.09 \log_e(i_{2W}/i_{2B})}{i_{2W} - i_{2B}} \dots \dots \dots (1.5)$$

APPENDIX 2.

During the sync pulse of duration τ_2 the equivalent circuit is Fig. A.1, where E is the source voltage at the tip of the sync pulse, V_C is the mean voltage on the coupling capacitor and r_d and e_d represent the diode. Let $r_2 = R + R_1 + r_d$. The current is

$$i_2 = \frac{E - V_C + e_d}{r_2} \dots \dots \dots (2.1)$$

During the picture period of duration τ_1 the equivalent circuit is Fig. A.2, where V_S represents the signal voltage. The diode is inoperative. The current is

$$i_1 = \frac{E - V_C + e_d - V_S}{r_1} \dots \dots \dots (2.2)$$

where $r_1 = R + R_1 + R_2$.

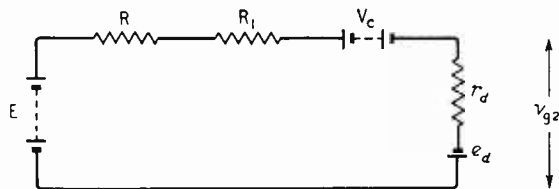

Fig. A.1

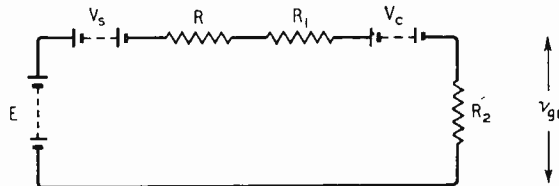

Fig. A.2

During a black picture $V_S = e_1$ for the whole period τ_1 ; therefore, i_1 is constant and of value

$$i_1 = \frac{E - V_C + e_d - e_1}{r_1} \dots \dots \dots (2.3)$$

It is necessary to have $\tau_1 i_1 + \tau_2 i_2 = 0$ in the steady state, hence

$$E - V_{CB} + e_d = \frac{e_1}{1 + \alpha} \dots \dots \dots (2.4)$$

where $\alpha = \frac{\tau_2 r_1}{\tau_1 r_2}$ and the extra subscript (B) indicates that the value of V_C is that for an all-black picture.

In the case of an all-white picture V_S has the value $e_1 + E_1$ for a period τ_3 and e_1 for a period $\tau_1 - \tau_3$. Consequently, the mean value of i_1 is

$$i_1 = \frac{E - V_C + e_d - e_1 - E_1 \tau_3 / \tau_1}{r_1}$$

and in the steady state we get

$$E - V_{CW} + e_d = \frac{e_1 + E_1 \tau_3 / \tau_1}{1 + \alpha} \dots \dots \dots (2.5)$$

where the subscript (W) indicates the value of V_C for an all-white picture.

The anode voltage during a sync pulse is

$$v_2 = i_2 r_d - e_d \dots \dots \dots (2.6)$$

and during a picture interval is

$$v_1 = i_1 R_2 \dots \dots \dots (2.7)$$

By straightforward substitution we get

$$v_{2B} = e_1 \frac{r_d / r_2}{1 + \alpha} - e_d \dots \dots \dots (2.8)$$

$$v_{2W} = (e_1 + E_1 \tau_3 / \tau_1) \frac{r_d / r_2}{1 + \alpha} - e_d \dots \dots \dots (2.9)$$

$$v_{1B} = -e_1 \frac{R_2}{r_1} \frac{\alpha}{1 + \alpha} \dots \dots \dots (2.10)$$

$$v_{1W} = -\frac{R_2}{r_1} \left[e_1 \frac{\alpha}{1+\alpha} - E_1 \frac{\tau_3/\tau_1}{1+\alpha} + E_1 \right] \quad \dots (2.11)$$

$$v_{1WB} = -\frac{R_2}{r_1} \left[e_1 \frac{\alpha}{1+\alpha} - E_1 \frac{\tau_3/\tau_1}{1+\alpha} \right] \quad \dots (2.12)$$

where v_{1WB} represents black level on an all-white picture. The values of V_S used in developing these equations are, of course, the peak values e_1 and E_1 .

The change of black level is

$$\Delta v_B = v_{1WB} - v_{1B} = E_1 \frac{\tau_3 R_2}{\tau_1 r_1} \cdot \frac{1}{1+\alpha} \quad \dots (2.13)$$

This is the maximum change of level that can occur with any change of picture content.

The value of r_a can be computed from equation (1.5) of

Appendix 1 with the aid of (2.1), (2.4) and (2.5), giving

$$r_a = \frac{(R + R_1 + r_1 \tau_2/\tau_1) \frac{0.09}{E_1 \tau_3/\tau_1} \log_e \left(1 + \frac{E_1 \tau_3}{e_1 \tau_1} \right)}{1 - \frac{0.09}{E_1 \tau_3/\tau_1} \log_e \left(1 + \frac{E_1 \tau_3}{e_1 \tau_1} \right)} \quad (2.14)$$

For the British television system $\tau_2/\tau_1 = 0.1125$, $\tau_3/\tau_1 = 0.927$, while in the signal as transmitted $E_1/e_1 = 2.33$. Allowing for the loss of sync pulse amplitude in the detector, however, $E_1/e_1 = 3$ is a more probable value at the receiver output. With these values

$$r_a = \frac{[1.1125(R + R_1) + 0.1125 R_2] \times 0.129}{E_1 - 0.129} \quad \dots (2.15)$$

WENVOE SERVICE AREA

WHEN the high-power (50-kW) Wenvoe television transmitter was brought into service towards the end of December, nearly 4.5 million people in Wales and the West Country came within its service area. This brought the percentage of the country's population within the areas served by television transmitters to over 78 per cent. The approximate population coming within the 100 $\mu\text{V}/\text{m}$ contour of each of the five transmitters (in order of opening) is Alexandra Palace (London), 11,558,000; Sutton Coldfield (Midlands), 6,909,000; Holme Moss (North of England), 13,384,000; Kirk o' Shotts (Scotland), 4,022,000; and Wenvoe (Bristol Channel), 4,494,000. This gives a total of nearly 40.4 million, which is approximately 78.5 per

cent of the country's population, according to the 1951 census.

The area within which consistently good reception of television transmissions can be expected naturally depends upon terrain, height of receiving aerial and intensity of electrical interference. This map showing the estimated field-strength contours for the 50-kW Wenvoe station has now been prepared by the B.B.C. and will serve as a rough guide to reception conditions in the area.

The field-strength at any given place may differ from the figure given on the contours (which represent average values) by as much as ± 10 db. In the shaded area considerable fading may be experienced.

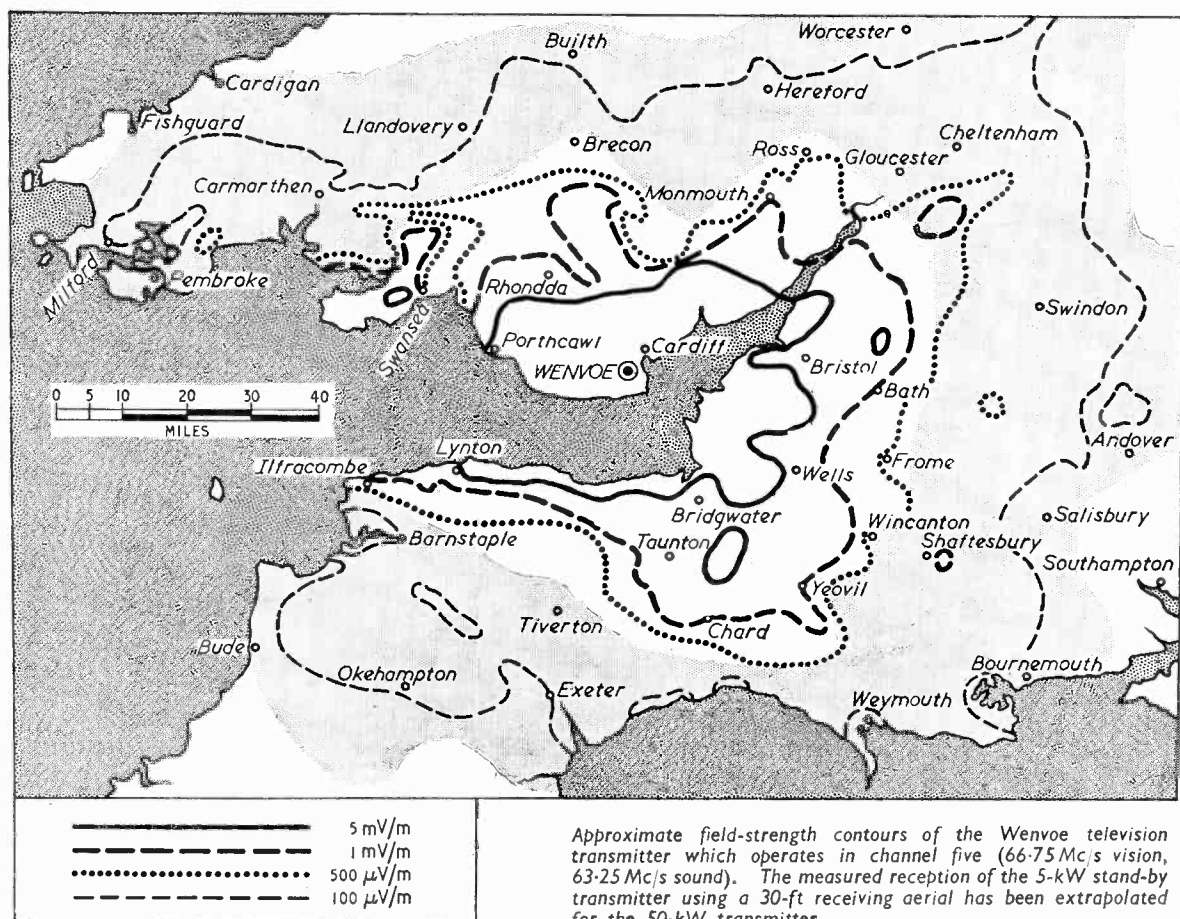

Designing a Tape

Part 1.—Tape Mechanisms and Recording Heads

By J. M. CARTER, B.Sc.*

In this series of articles, it is proposed to examine the problems arising out of the design and construction of a high-quality magnetic tape recorder and to outline some specific means for their solution. The text is therefore written more from the standpoint of a development engineer dealing with practical difficulties than from that of the research worker concerned with theoretical concepts and possibilities. Constructional details and actual circuit values will be included for those parts which can be made without special tools or equipment.

THE most important parts of a tape recorder, and those also which give the most trouble in manufacture, are the tape driving and spooling mechanism and the recording and playback "heads." With the former, the chief difficulty is that of transporting the tape over the heads at an absolutely constant speed, any irregularity immediately manifesting itself as either a low-frequency "wow," giving an undesirably tremulo effect to the reproduction, or a higher-frequency "flutter" which imparts noticeable edge or roughness to speech or music.

To obtain the necessary speed constancy, a "pinch" type of friction drive is invariably applied, in which the tape is drawn between two rollers held together by spring pressure. One (the capstan) is driven so as to have a peripheral speed equal to the required tape speed, whilst the other (the pinch roller) runs as an idler. To achieve the necessary traction with freedom from slip, the capstan must have a surface with a high coefficient of friction, and yet be perfectly

true and smooth. A metal core with an accurately ground Neoprene rubber "tyre" has been found very satisfactory in this respect, with the reservation that some form of lever or cam movement is fitted to lift the engaging metal roller clear during stationary periods and so prevent any tendency for "flats" to form.

Whilst it is obvious that the capstan must be ground concentric to within the finest possible limits, it may not appear so important to do this also for the pinch roller; however, if this is eccentric the capstan, over some part of its revolution, will be lifting it against its spring pressure, and the increased effort incurred, translated into terms of resistance to motion, may result in "wow." It must be remembered that we are dealing with a speed variation of the order of 0.1 to 0.2 per cent, and that, taking the recording and playback processes into account, the original "wow" will always be doubled in the worst case.

Almost as important as the concentricity of capstan and pinch roller is the quality of the bearings on which they are mounted. Any slight variation in friction over any one part of a revolution will react unfavourably on the "wow," which means that the bearings must be of the highest possible quality.

To assist in smoothing out any high-frequency fluctuations in speed, it is usual to have a flywheel

* Wright and Weaire Ltd.

General view of underside of the "Wearite" Tape Deck. Separate motors are used for the capstan, the supply reel and the take-up reel. Control of the mechanisms is effected principally by a rotary switch to which all necessary mechanical movements are coupled by a system of cams and levers.

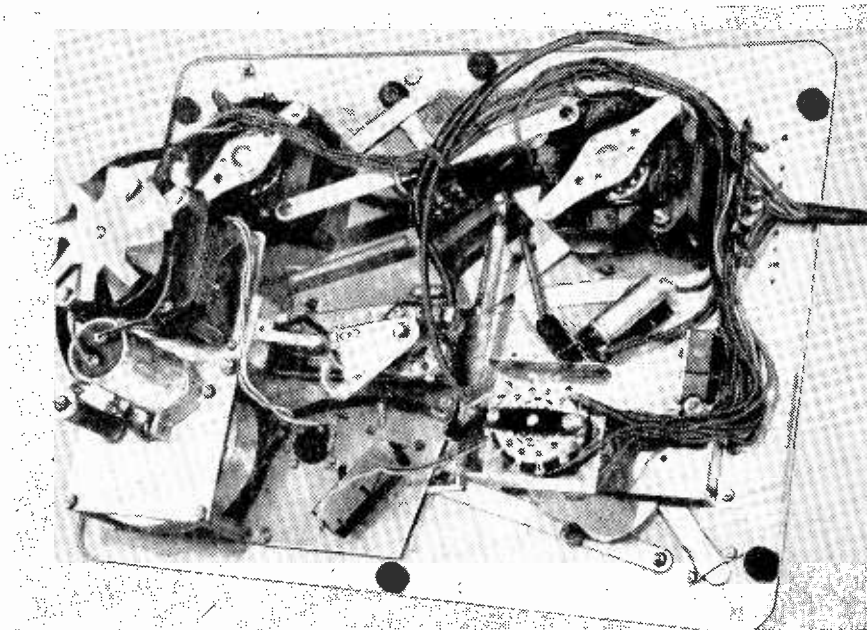

Recorder

mounted either on the capstan spindle or integral with the capstan itself. The whole assembly should be dynamically balanced and, because of its extra mass, mounted on ball races.

The actual drive from the motor spindle to the flywheel-capstan combination is most easily effected by an intermediate rubber-tyred idler wheel, spring-loaded between a lightly knurled pulley on the motor shaft and the rim of the flywheel. The very small amount of slip in such a combination is acceptable for all but the most stringent requirements; for example, where the running time must be within, say, one second in thirty minutes. This type of drive has several advantages over the alternative direct (capstan on motor spindle) method. First, the diameter of the capstan is not fixed by the motor speed and its size may be fixed by other considerations, such as optimum traction, ease of manufacture, etc. By "stepping" the motor pulley diameter, the capstan speed can be arranged to have two or three fixed values, by simply moving the intermediate idler up and down, or by engaging alternative intermediate wheels.

Finally, it is possible to keep the capstan motor, with its external magnetic field, away from the immediate proximity of the playback head. Different motors vary widely in the frequency components and magnitude of their external field, which is dependent upon the working flux density, the rotor design and other factors, and it can prove to be very troublesome.

Three-motor Drive

The idea of employing additional separate motors for both the take-up and supply reels is becoming increasingly popular, and, where the small increase in weights is not a major consideration, has much to recommend it on the score of mechanical simplification, reliability and flexibility. The "Wearite" Tape Deck, for example, employs such a three-motor drive, and has an interesting method for switching the motors in the various operations such as playback, record, wind-on and wind-back. The normal direction of rotation of the supply reel motor is clockwise and that of the take-up reel motor anti-clockwise, and both are wound for a normal running voltage of 150. On "Playback" and "Record," the mains voltage of over 200 is applied across both motors in series, and, in addition, a shunt resistor is switched across the supply reel motor to reduce its terminal voltage. The take-up reel motor then has approximately its normal running voltage applied, and, working in a partially stalled condition, takes up the tape issuing from the capstan, whilst the supply reel motor, running at a reduced voltage and also stalled, exerts a reverse pull on the tape being unwound from the reel and keeps it taut. On the "Wind-on" and "Wind-back" positions, the full mains voltage is switched across the relevant motor, the other running free, and as this amounts to a 66 per cent short-duration overload, a very fast wind, even with the new 8½ in reels, is obtained.

The method of braking the reels, especially during the fast wind-on and wind-back operations, is impor-

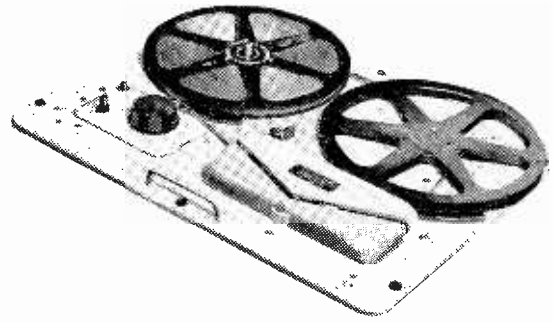

tant and it is obvious that the reel from which the tape is being unwound should have the greater braking torque applied. A very neat and simple form of mechanical braking, fulfilling this condition, consists of semicircular rubber brake shoes bearing externally on the small drums which normally support the reels.

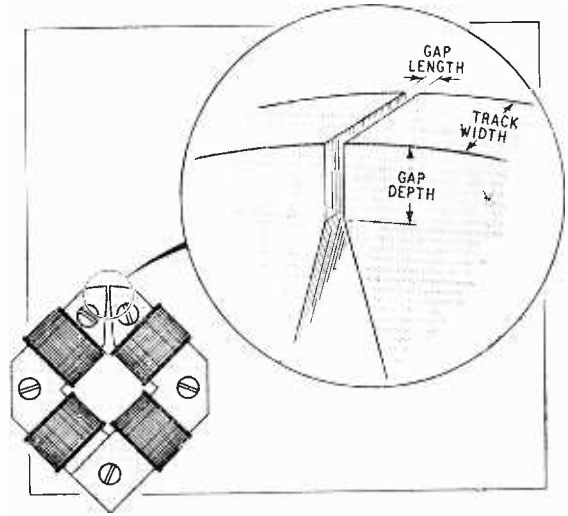
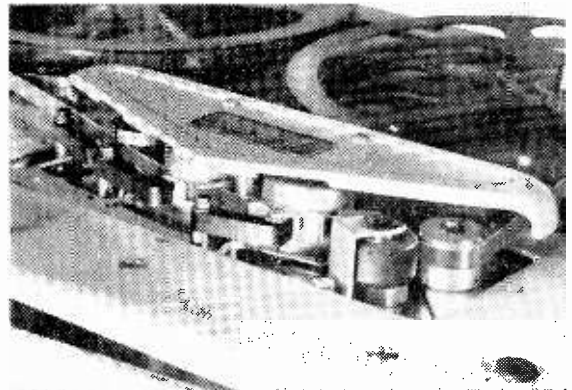

Fig. 1. Twin track record playback head showing diagrammatically the important dimensions of the gap. In both sketches the gap length has been much exaggerated.

Head and capstan assembly showing (right to left) pinch roller, capstan, record reproduce head, erase head and tape-operated automatic switch.



These brake shoes are pivoted at one end and so arranged that they each tend to wrap around the drum when the appropriate reel is unwinding. In this direction the braking torque is much greater than that in the counter direction in which the driven reel will be rotating, and so the necessary differential braking is obtained.

Turning now to the question of head design and manufacture it is perhaps obvious that a full discussion of the theory and the practical problems involved would require several such articles as this, and only a brief review will be attempted to indicate the principle design points and outline the necessary manufacturing processes. To deal first with the choice between twin-track or full-width track heads, for practically all home recorders and semi-professional equipments, the twin-track head is to-day in universal use, as it has the enormous advantage of doubling the playing time per reel when facilities for "editing" the tape are not required. If editing is desired, only one track need be used, which means that the only real disadvantage is the reduced output (theoretically 6db) from the twin-track head, as compared with the full-track head, and as this only becomes of major significance when signal/noise ratios of 60db and over are sought,

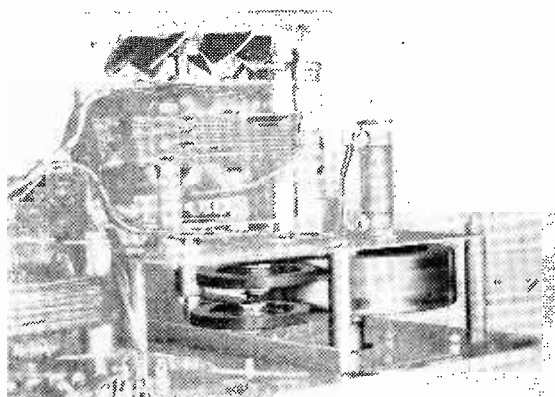

Capstan flywheel, twin idler wheels and "stepped" motor spindle giving alternative tape speeds of $7\frac{1}{2}$ and $3\frac{3}{4}$ in/sec.

Semicircular rubber brake shoe on one of the drums supporting the tape reels motor spindles.

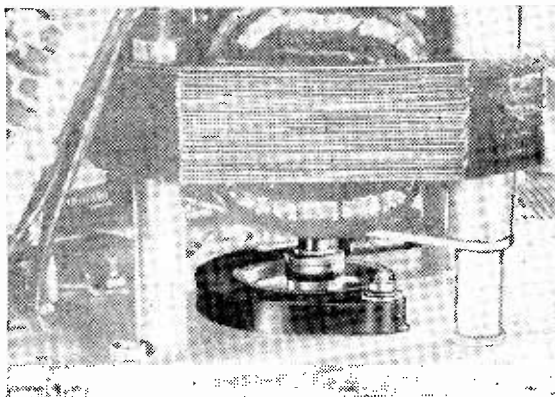

as in the best professional broadcasting equipment, it is far outweighed by the attendant advantages.

Fig. 1 shows the main features of a commercial record/replay head suitable for twin-track operation. For a good frequency response the effective gap (as distinct from the physical gap) should not exceed 0.0005in. A gap of 0.0003in is a better target. In addition it must be clearly defined, have straight parallel sides and be at right angles to the centre line of the tape if it is to line up with other instruments and play back their recordings with no loss in high frequencies. This "gap tilt" effect is also often overcome by mounting the head so that it can be rocked slightly from side to side while a standard high audio frequency is played back, the head being finally clamped at that angle which results in the maximum output. The adjustment is quite sharp; for example, with a wavelength of 0.001in corresponding to a frequency of 7,500 c/s at 7.5in/sec, a head tilt of half a degree between the line of the gap and the original recording results in a loss of 17db.

Also of vital importance to the general characteristics of the head is the depth of the gap (Fig. 1), which appears to have an optimum size for maximum "pick up" and minimum distortion as well as determining the correct bias and recording levels. Mumetal, or some such high-permeability material is practically essential for the head laminations which must be kept thin (and insulated) to reduce losses. As is well known, such materials suffer a considerable loss in permeability when cut, ground or even bent, and must be re-annealed after mechanical finishing. The construction of the erase head is essentially similar to that of the record and playback head, the main difference being in the smaller winding turns and the larger gap, which is not particularly critical, an average value being from 0.003 to 0.005in.

Tape Contact

An important feature in connection with the heads is the use of small "pressure pads" to ensure that the tape is in intimate contact with the surface of the head in the gap region. This is necessary because of the extremely small "spread" of the magnetic field from the head when recording, and from the tape when playing back. If contact is poor, wild variations occur in the amplitude of recorded constant tones, especially at the higher audio frequencies, and with many present-day tapes the effect can be cured only by the use of a pressure pad. The reason for this lies in the "backing," i.e., the 0.002-in thick cellulose-acetate strip on which the coating is deposited. If this is slightly concave or is overstretched along any edge, good contact over the full width of the head laminations is lost, the effect being worsened by the double loss on playback and record.

From this short introductory review it will be evident that the average enthusiast wishing to construct a high-quality instrument entirely at home would have many experiments to make and difficulties to overcome before arriving at a really satisfactory performance. On the other hand a compromise is possible by purchasing the complete mechanical unit, and building only the amplifier, its associated oscillator and a level indicator. For amateurs without a well-equipped workshop this course is strongly recommended.

(To be continued. Part 2 will discuss the design and include a recommended circuit for the amplifier, oscillator and level indicator.)

Cushion that Switch-on Surge in AC/DC receivers

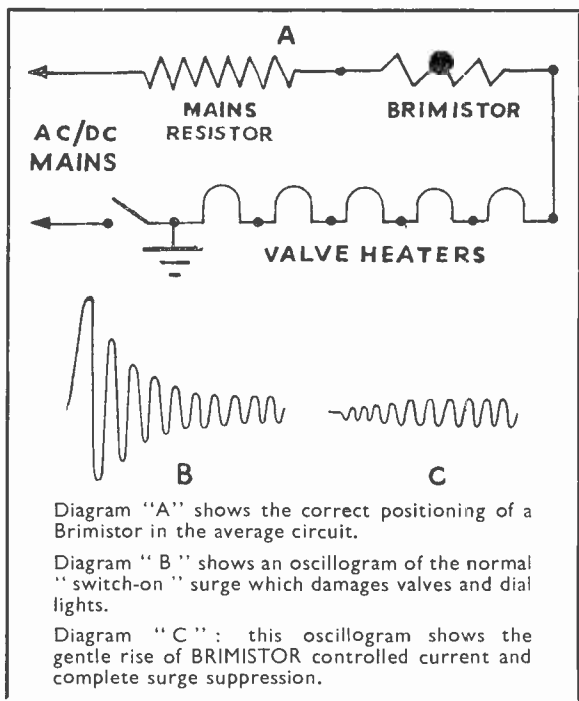

Wired in series with valve heaters . . . dial lights . . . BRIMISTORS hold the starting current at a low value, permitting it gradually to rise until working temperature is reached, thus ensuring maximum life for both valves and lamps. When cold the resistance of a BRIMISTOR is high. As it warms up with the passage of current, however, this resistance falls *gradually* to a very low level which usually can be ignored. At the very most a small reduction in the line cord or other voltage dropping resistance will provide the necessary compensation.

CHARACTERISTICS OF BRIMISTORS

Type	Cold resistance at 20° C.	Resistance with the following currents flowing				Max. Current	Price List
		0.1 amp.	0.15 amp.	0.2 amp.	0.3 amp.		
CZ1	3,000	180	100	75	44	amp. 0.3	*3/6d
CZ2	5,500	170	90	66	38	0.3	*3/6d
CZ3	1,500	100	50	35	—	0.2	*1/6d
C4	760	—	—	—	—	1.25	*5/-d
CZ6	3,000	200	120	80	45	0.45	*3/6d

* Brimistors are not subject to Purchase Tax.

Use CZ1 for 0.3 amp. and 0.1 amp. valves.

Use CZ2 for 0.15 amp. and 0.2 amp. valves.

Wire type CZ3 across the dial lamp (in conjunction with a CZ1 or CZ2 as above).

Notes on the use of BRIMISTORS

- Owing to the high operating temperature (up to 250° C.) Brimistors must be spaced away from coils and waxed components.
- They should be inserted in the "live" end of the heater chain—i.e. between mains resistance and rectifier valve heater.
- At least 1/2 in. of wire must be left at each end before soldering to a tag.

BRIMISTORS are used in all popular AC/DC Television Receivers—ADD SOME TO YOUR STOCK

CURRENT SURGE
BRIMISTOR
RESISTORS

Standard Telephones and Cables Limited FOOTSCRAY, SIDGUP, KENT.
makers of BRIMAR VALVES and BRIMAR TELETUBES

for either standard or L.P. records — just turn the knob!

balanced, distortion-free

reproduction



The G.P. 29-2 cartridge as fitted to the G.P.30 pick-up is available to gramophone and radio manufacturers. Leading makers already fit it in very large numbers. Retail price in Gt. Britain 30/- plus P.T. 13/4

extremely kind to

records

The G.P.30 crystal turnover pick-up is intended to provide the largest number of record enthusiasts with the best possible reproduction of standard and microgroove records when used in conjunction with commercial equipment such as the normal radio set. The output characteristics give balanced distortion-free reproduction with minimum surface noise. And the use of this Pick-up ensures long record life; the careful design gives exceptional tracking capabilities at the low stylus pressure of ten grammes.

the Acos

GP 30

turnover crystal pick-up

Price in Great Britain £2.10.0
plus P.T. 21/5.

always well ahead

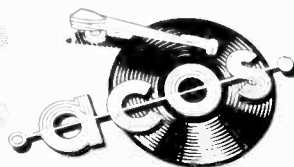

STANDARD-LONG PLAYING

COSMOCORD LIMITED ENFIELD MIDDLESEX

New High-Grade Condenser Microphones

(Concluded from p. 54 of the previous issue)

2.—Details of Neumann Types M50 and U47 and Associated Power Supply Units

By F. W. O. BAUCH

AS was described in the previous issue, the new pressure-gradient condenser microphone (Neumann, Type M49) makes use of the combination of two equal cardioid condenser systems mounted back to back, i.e., with their maximum sensitivity in opposite directions. The addition of their output voltages gives the resulting voltage as

$$e = e_1(1 + \cos \alpha) + e_2(1 - \cos \alpha)$$

which can be expressed as

$$e = (e_1 + e_2) \cdot \left[1 + \frac{e_1 - e_2}{e_1 + e_2} \cdot \cos \alpha \right]$$

The form of the characteristic, therefore, depends on the ratio of the difference to the sum of the output voltages of both microphone systems. A flat frequency response of the combination necessitates a flat response of the single microphones.⁴

New Pressure-type Condenser Microphone. The Neumann Type M50 microphone is deliberately built in such a way that the response at high frequencies becomes slightly directional with a slight increase of output. This effect can be observed on its polar diagram (Fig. 15) and its frequency response curve (Fig. 16). In a diffused field of sound the frequency response of the microphone is practically flat.

Fig. 15. Polar diagram of Neumann Type M50 pressure microphone.

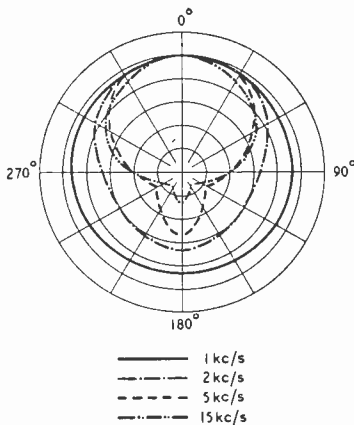

Fig. 17 shows the interior of the M50 microphone after the protecting cover, which consists of a triple layer of different metal gauzes, has been removed. A flexibly mounted Perspex sphere with a diameter of 40 mm carries, flush-fitting on one side, the actual condenser capsule with the highly stretched diaphragm of an effective diameter of 12 mm. The size of the Perspex sphere was chosen for the above mentioned increase of frequency response to a plane wave front, starting at about 1,000 c/s. The diameter of the

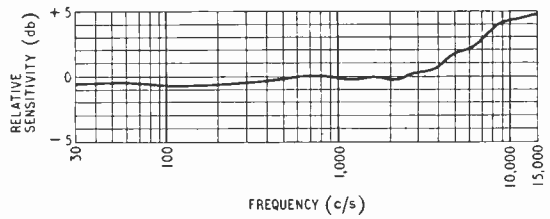
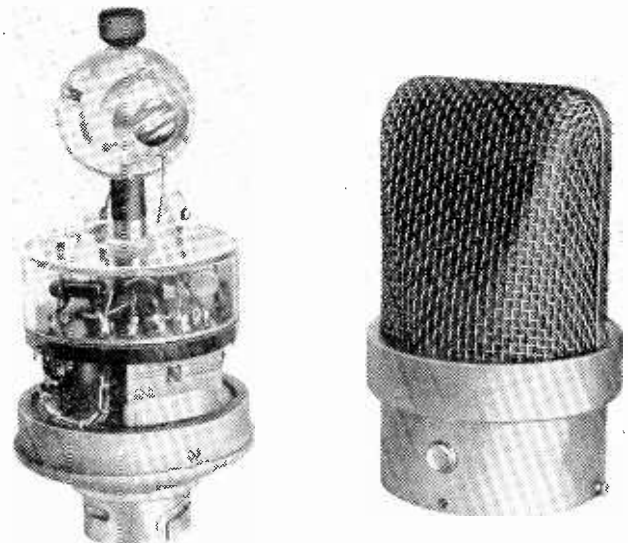

Fig. 16. Frequency response curve of Neumann Type M50 microphone.

Fig. 17. Neumann Type M50 microphone with cover removed.



⁴ H. Grosskopf, *Techn. Hausmitt. des NWDR*, Vol. 4 (1952), p. 209.

diaphragm is sufficiently small compared with the sphere diameter to maintain a favourably broad directional characteristic of the microphone at high frequencies. The capacitance of the capsule, however, must not be too small with respect to the detrimental input capacitance of the amplifier. A sufficiently large capacitance can be produced by an extremely small distance between the diaphragm and the fixed electrode, this distance being here 10μ ($1\mu = 1/1000$ mm). Again, the diaphragm is made from an insulating foil (Polystyrol) of a thickness of 12μ , sputtered with a pure gold layer on one side. These insulating foils are used with much advantage, as they simplify the construction of the capsule and give protection against accidental short circuits between the metallic side of the diaphragm and the fixed electrode. The extremely small mass of such foils, if compared with that of pure metal diaphragms, permits the application of relatively small polarizing voltages to obtain a sufficiently large electrical output.

As stated before, the diaphragm of the M50 capsule is highly stretched, but its resonance of approximately 15 kc/s is mainly determined by the stiffness of the air cushion behind the diaphragm. Suitable cavities in the surface of the fixed electrode are designed for an aperiodical damping of the diaphragm, thus making the transformation of mechanical into electrical oscillations independent of frequency below the resonance of the diaphragm.

The frequency response of the M50 microphone covers the range from 40 to 15,000 c/s, with a gradual increase of up to +5db when exposed to direct sound. Other data are: sensitivity, approx. $0.7\text{mV}/\mu\text{b}$; overall noise, $<2\mu\text{V}$; output impedance, 200 ohms.

Fig. 18. Type N48 a.c. mains operated power supply unit for the M49 and M50 microphones.

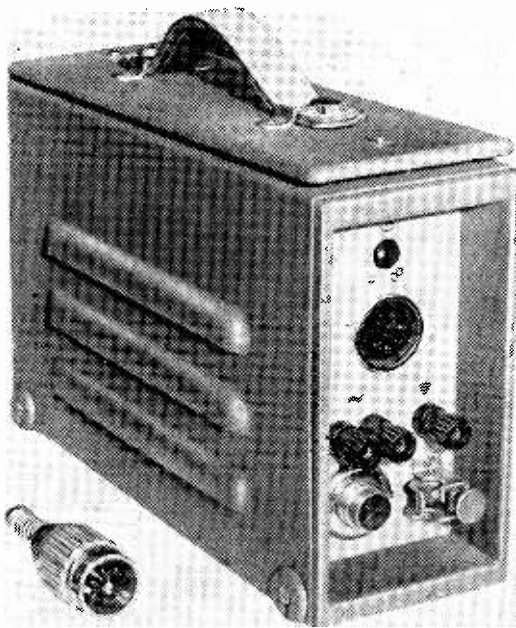

The physical dimensions (also those of the are: overall height, 163 mm; greatest diam. 80 mm; weight, 800 gm. The built-in amplifier, principally the same as that used for the M49 microphone, and is housed below a similar detachable Perspex cover which carries on its top the actual microphone. The output transformer is mounted further down, and the whole assembly fixed to a soft rubber disc as a protection against mechanical vibrations. The threshold noise generated in microphone plus amplifier is of the order of 18-20 phon which compares with the noise of an empty quiet broadcasting studio.

Power Supply Units for Neumann Type M49 and M50 Microphones.—Fig. 18 shows the portable a.c. mains power unit Type N48. The multiple plug connection in the middle of the front panel serves to connect the microphone via a screened rubber-coated cable which carries the voltage supply to and the signal output voltage from the amplifier, the latter being made available at the 3-pin plug in the left lower corner. All plug connections are of the novel and most reliable self-cleaning "Tuchel" type, the counterpart of the multiple socket being shown on the left. On the right-hand side are a handy cable clamp and, above, three terminals, provided for test or measuring purposes, which are connected in parallel with the signal-output plug. The potentiometer for the adjustment of the directional characteristics on the M49 microphone is situated on the upper part of the panel. In the photograph it is set to a position half way between omni-directional (circle) and cardioid. The back panel contains the mains input, mains switch, signal lamp and fuses. The electrical layout incorporates two rectifier circuits for the provision of all necessary voltages and currents for the amplifier, including the polarizing voltages for the condenser capsule.

A second mains power unit, Type N49, incorporating the same circuit diagram, is provided in panel construction for rack mounting. For outside broadcasts, or where there is no mains supply available a portable unit, Type B9, enables the microphones to be operated from internal batteries.

These three units also serve the M50 microphone, in which case the adjustable polarizing voltage is automatically out of action.

The standard length of the screened multiple cable between microphone and power supply is 10m or roughly 33 ft. Experience showed that this length can, if necessary, be increased to a maximum of about 100 ft, without any changes in frequency response. With the higher ohmic resistance of the cable, however, heater current adjustment must be made inside the power supply units.

Neumann Type U47 Microphone

A less costly layout of a pressure-gradient condenser microphone of very high performance, incorporating a choice of two fixed directional characteristics (cardioid or omni-directional), is the Neumann Type U47 with its own mains supply unit and microphone cable, the latter fitted with a device for tilting the microphone to any desired angle. Both characteristics can conveniently be selected on the front of the microphone by means of a to-and-fro switch with indicator for the chosen position.

The exterior of the Neumann Type U47 microphone is shown in Fig. 19. The upper part of the

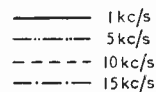
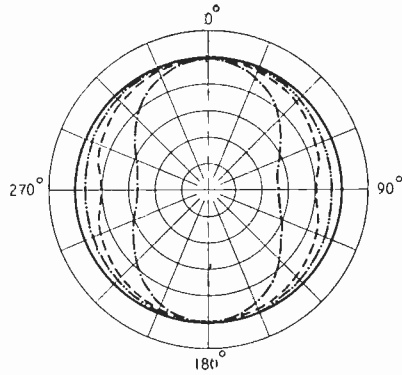
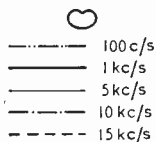
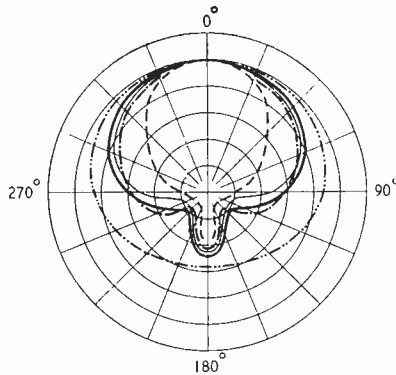

Left: Fig. 19. Neumann Type U47 microphone. Above: Fig. 20. Alternative polar diagrams available in the Neumann Type U47 microphone. Right: Fig. 21. Frequency response curves of the Type U47 microphone.

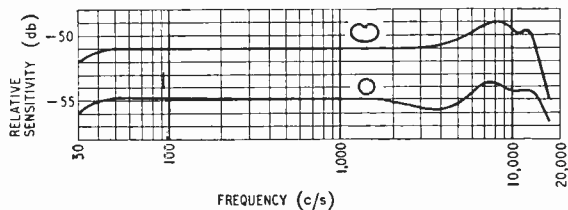

microphone consists of three protective layers of different wire mesh, and houses the condenser capsule as well as the switch for changing its directional characteristic, the setting of which can be observed in an oval Perspex window inside the metal belt of the cover. In the photograph the microphone is switched to the cardioid position.

The condenser capsule of the U47 microphone is identical with the capsule of the M49, and consists of a perforated fixed middle electrode with two equal diaphragms on either side. One diaphragm is permanently connected to a polarizing voltage. If an omni-directional characteristic is required, the other diaphragm receives the same voltage, which is also of the same direction, via the above mentioned switch. For the cardioid, the switch disconnects the polarizing voltage from the second diaphragm and connects it to zero potential.

The principle of operation is similar to that of the M49 capsule, with the difference that here two characteristics may be chosen and that these are obtained by means of a clear switching-over from one form to the other. The available polar dia-

grams can be seen in Fig. 20; the respective frequency response curves are shown in Fig. 21.

Fig. 22 gives a picture of the U47 microphone as opened for servicing. The top part with the capsule and the switch is a complete unit by itself, connected to the amplifier assembly on the right by way of a special "Tuchel" 2-pin plug. The valve chosen for the single-stage amplifier is the Telefunken Type VF14, an indirectly heated steel-envelope valve with a 55-V heater. This valve is suspended on soft rubber tapes, upside down, and surrounded by a sponge-rubber ring to intercept any possible micro-

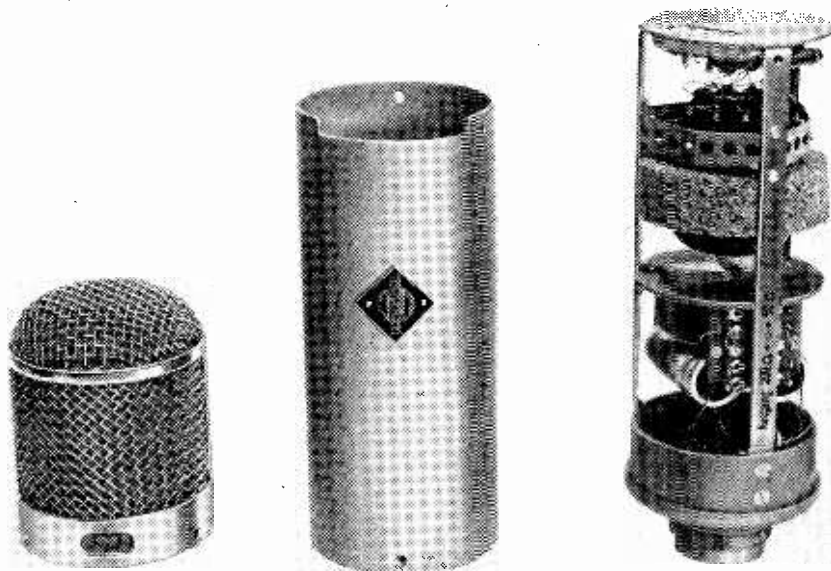

Fig. 22. Type U47 microphone partially dismantled with the amplifier unit on the right.

phony. All other component parts including the output transformer with a switching device for either 50 or 200 ohms matching output impedance, are mounted lower down.

The electrical data of the U47 microphone are: frequency range, 40-15,000 c/s; sensitivity, 2.5mV/ μ b; overall noise, approx. 1.5 μ V (<18 phon); overall distortion up to 120 phon, <1%; output impedance, 50 or 200 ohms. The physical dimensions are: overall height, 240 mm; largest diameter, 63 mm; weight 700 gm.

Fig. 23 gives a view of the a.c. mains supply unit, Type NG, which is surprisingly small, yet supplies the microphone and amplifier with all necessary voltages and currents from one bridge-connected selenium rectifier with smoothing circuits. The heater supply branches off from the anode voltage supply, bringing the overall d.c. current of the mains unit to only 40mA, with a maximum d.c. voltage of 100 volts. The overall dimensions are 220 x 100 x 120mm. The microphone cable input and the signal output are situated on the front panel. The back panel contains the a.c. mains input, the mains switch, a signal lamp, and a fuse.

The standard length of the microphone cable with "Tuchel" plug fittings is again 33 ft, but the permissible maximum length in this case can be as much as 200 ft.

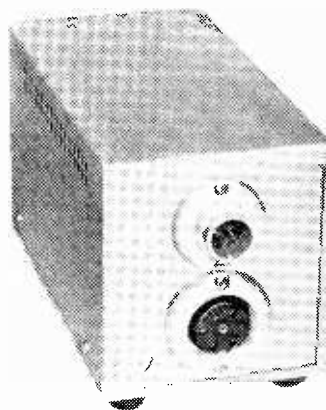

Fig. 23. Type NG mains supply unit for the U47 microphone.

Acknowledgment—I would like to take the opportunity to convey my thanks to Georg Neumann GmbH, Berlin and to the Nordwestdeutsche Rundfunk, Hamburg, for placing comprehensive data at my disposal.

Shared Television Channels

How Horizontal Polarization at One Station May Limit Mutual Interference

By F. R. W. STRATFORD,* M.I.E.E., S.M.I.R.E.

THE good news that two of the proposed five medium-power television transmitters will be in operation for the Coronation provides a timely opportunity for discussing the reception problems which may arise when channels are shared. The British Isles is not a large territory and the problem of channel sharing between these transmitters and their high-powered brothers requires most careful planning.

If normal wave propagation over a conductive surface was the controlling factor a separation of 200 miles between common-frequency transmitters of the present power would be adequate in removing mutual interference since the field strength involved would be many decibels below the input noise level of the receiver.

Although wave propagation theory is exceedingly complex some generalizations may be made. The viewer is essentially interested in receiving the ground wave. This wave does not rely upon atmospheric or ionospheric properties to aid or retard its propagation

and could be regarded as the "in-vacuo" wave. It is this ground wave which provides the steady signal well within the fringe limits of reception.

The ground wave may be split into two components, (a) the direct wave and (b) the ground reflected wave. Usually the viewer receives a combination of (a) and (b) and rarely the direct wave only. Reference to Fig. 1 (a) and (b) should make this clear. In the case of direct wave reception the signal intensity of field strength is inversely proportional to the distance d , of separation between the transmitter and the receiver.

In the more usual case, where the received signal is a combination of the direct and ground-reflected wave, it can be proved that the resultant signal is considerably weaker, due to partial phase cancellation and in practical terms the field strength is no longer inversely proportional to d but to d^2 . Hence, for the usual mode of reception, doubling the distance reduces the signal strength by a factor of four. It is important to remember these generalized facts as they are involved when the problem of anomalous propagation is next discussed. Apart from the normal mode of

* Belling and Lee Ltd.

propagation anomalous effects may be introduced by the ionosphere or the troposphere.

The ionosphere is that part of the upper atmosphere which is capable of becoming partially electrically conductive due to ionization, and lies between about 50 and 400 kilometres above the earth's surface. The reflecting properties of the ionosphere are essential for world-wide shortwave communications, but it is indeed fortunate that these properties almost completely disappear at television and higher frequencies. Very rarely a set of favourable conditions arise when television signals may be propagated across the Atlantic, and a case is on record of the reception of Alexandra Palace in Johannesburg.

We can therefore neglect ionospheric reflections in dealing with the problems of channel sharing for television and pay attention to a newer phenomenon, namely, tropospheric propagation. The troposphere is that part of the earth's atmosphere extending up to about 10 kilometres. It does not become ionized to an extent sufficient to reflect radio waves, but can bend them by refraction just as light is bent when it passes through a medium of varying refractive index.

Dielectric constant, or permittivity, may be likened to the refractive index in optics. A radio wave propagated in a horizontal direction through a medium in which the dielectric constant varies along the vertical section will be refracted as depicted in Fig. 2(a). It will be seen that a skyward bound wave can only be refracted earthwards when the dielectric constant, K , of the atmosphere is decreasing with height and this is the condition which can give rise to tropospheric propagation.

An extreme condition in which there is a sudden drop in K in the upper troposphere can give rise to reflections which may be regarded as a special case of super-refraction, Fig. 2(b). Propagation under these conditions is often referred to as "ducting."

(c.f.—The dielectric constant of air is only minutely greater than unity. At zero centigrade temperature, and normal atmospheric pressure, it is 1.00059 and is slightly dependent on temperature, T , atmospheric pressure P , and partial pressure of water vapour E).

A close approximation to the dielectric constant of humid air is given by the expression

$$K = 1 + \frac{160}{T} \left[P + \frac{4800E}{T} \right] \times 10^{-6}$$

From this it can be seen that K will be decreased and cause earthwards refraction, or reflection, when the temperature increases, or the barometric pressure decreases, with increasing height. In the normal atmosphere the pressure and temperature both decrease with height and largely cancel their mutual effect upon the value for K , hence, insignificant refraction takes place and propagation is of the normal ground wave type.

Certain atmospheric conditions however can lead to an increase of temperature, or a rapid drop in humidity (or both), with height. When this occurs super-refraction sets in and some of the upwardly directed energy from the transmitter is returned to earth as indicated by a marked extension of the usual ground wave range. The best meteorological conditions for such propagation may be stated as warm, foggy, and anticyclonic conditions which are more common in summer than in winter. The subject is well treated by Heightman¹ for those who wish to

extend their studies of tropospheric propagation.

The important point to remember is, that the transmitted wave energy returned to the receiving site due to super-refraction is governed by the inverse d law and not d^2 so that it does not attenuate so severely as the ground-wave. This accounts for the much greater distances achieved when the "freak" conditions are present.

Thus, with the present television powers, it seems essential that the spacing of the shared-channel transmitters must be at least four times the normal steady signal range, but other facts, geographical and technical, may not permit of this separation. Belfast will share frequencies with Alexandra Palace, a distance of 320 miles and Newcastle with Wenvoe, a distance of 250 miles.

It is hoped that such separation is unlikely to produce any serious mutual interference which, in the event of it arising, will be worse at receiving points lying

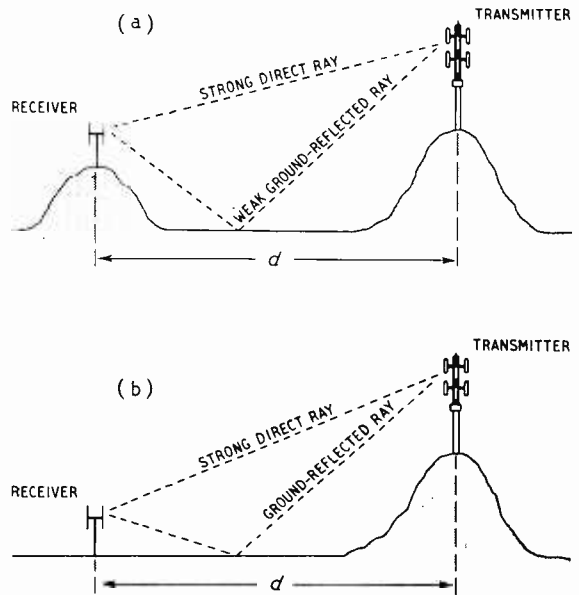

Fig. 1. Received signals consisting of ground-reflected and direct rays, (a) unusual condition with weak ground reflections and (b) more usual with strong ground reflections.

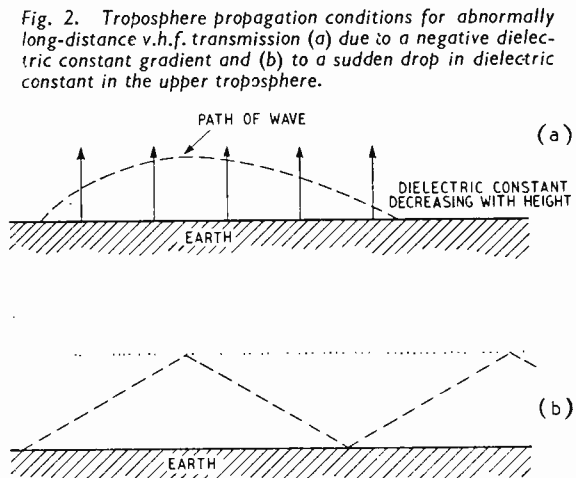

Fig. 2. Troposphere propagation conditions for abnormally long-distance v.h.f. transmission (a) due to a negative dielectric constant gradient and (b) to a sudden drop in dielectric constant in the upper troposphere.

¹ D. W. Heightman. "Propagation of Metric Waves Beyond Optical Range." *Journal Brit. I.R.E.* Vol. 10 No. 10 1950, p. 295.

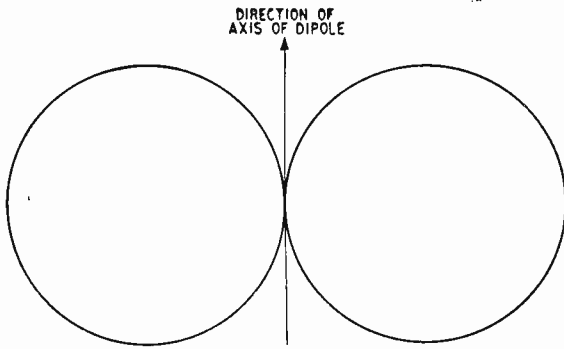

Fig. 3. Directional response of a simple horizontal half-wave dipole.

between the two transmitters. This is important because a directional receiving aerial, possessing a good front-to-back discrimination will be most helpful.

A further degree of freedom from mutual interference may be obtained by the simple expedient of changing the plane of polarization of the radiation field from one of the transmitters. It has been ascertained that the plane of polarization of waves which have been super-refracted, is not seriously affected. Were it, for example, converted to circular polarization by these effects, a vertical or horizontal aerial would respond equally well and nothing would be gained by the expedient.

Theoretically a horizontal receiving dipole should be incapable of receiving a vertically polarized wave, since no e.m.f. would be induced in it. In practise there is from 10 to 20 decibels discrimination only. This is due to the scattering effect of reflecting objects such as trees and buildings, which can account for many angles of polarization for the final waves exciting the receiving aerial.

Nevertheless an additional 10 decibels discrimination will be valuable during "freak" conditions and the B.B.C. are fully justified in deciding upon horizontal polarization for Belfast and Newcastle on these grounds. Because horizontal receiving aerials must be used the advantages and disadvantages of so doing must be discussed.

There are certain attractive advantages to be gained. In the first place a simple vertical dipole is omnidirectional, but when horizontally disposed it possesses directional characteristics resulting in a figure-of-eight response, the two zeros occurring in the direction of each tip of the dipole (Fig. 3).

This feature can assist in removing troublesome reflections (ghosts) emanating from the sides of the receiving site without recourse to multi-element arrays. Generally, the more troublesome reflections are from obstacles at the rear of the receiving site. The author has discussed this previously at some length,² and in these circumstances a dipole with two or more parasitic elements disposed as reflectors, directors, or combinations of the two, will be required.

It is important to recognize that, for a given number and disposition of parasitic elements, the horizontally disposed array will possess greater directivity than its vertical counterpart. This is obviously due to the minimum responses in the directions along the axis of the horizontal elements.

The foregoing is only true when the elements are parallel with one another. Any deviation in the form of a V or X arrangement of elements will vitiate this statement. Thus the simple "H" or "yagi" type of array is likely to prove a better "deghoster" when horizontally disposed. Also the amplitude of discrete ghosts is likely to be diminished since the majority do arise from tall (vertical) structures.

It is also known that ignition interference is predominantly vertically polarized. Some measurements³ made at a fairly open site near the Great Cambridge Road suggested that a reduction of some 10 decibels may be obtained by the use of a horizontal receiving aerial. Finally, the download or feeder from the aerial does not lie in the plane of the elements and thereby modify its intrinsic electrical properties. At the same time this symmetrical form of feeding will reduce the amount of electrical interference which may be induced in the aerial elements due, (a) to out of balance effects in the feeder, and (b) to tighter electrical coupling between the feeder and the aerial.

Turning to the disadvantages. The conventional television aerial elements are generally constructed from tubes of light alloy, and the wall thickness is calculated on the basis of wind forces up to hurricane strength plus a safety margin. The elements of an aerial so designed tend to sag due to gravity when horizontally disposed. Perching crows will also increase this tendency and some permanent "set" may result. It is therefore necessary to increase the wall thickness of the elements with subsequent increase in cost.

The second disadvantage is a considerable increase in picture brightness flutter due to reflections from passing aircraft. It is well established that such reflections are from 6 to 12 db stronger when received by a horizontal aerial, so that viewers on a busy aircraft route may suffer a certain amount of inconvenience in this respect.

The best way of summarizing the subject is to recapitulate by tabulating the advantages and disadvantages of employing horizontal polarization for one station sharing a transmitting channel with another at a reasonable distance.

Advantages	Disadvantages
Greater immunity from mutual interference during conditions of anomalous propagation.	Slightly increased cost.
Improved directional response of simple receiving aerials.	Greater liability to picture flutter due to aircraft.
Greater freedom from interference.	
Probable greater freedom from ghosts.	

It is not always wise to be prophetic in the optimistic sense but the writer is firmly convinced that the choice is wise and that the gains will more than outweigh the losses and that it is extremely unlikely that any unrevealed snags will arise in practice.

² F. R. W. Strafford "Receiving Aerials for British Television." Paper No. 1287R. I.E.E. Television Convention. April-May 1952.

³ F. R. W. Strafford "Experiments with Television Aerials." *Wireless World*. Vol. 39, 1936, p. 394.

LETTERS TO THE EDITOR

The Editor does not necessarily endorse the opinions expressed by his correspondents

Recording of Broadcasts

MAY I be allowed to comment on the leading article of your January issue?

Copyright has been based for a very long time on the right of an author, artist or composer to prevent another person from copying an original work, such as a book, a tune, or a picture which he has created. More recently this concept has been extended, and now gramophone records enjoy copyright protection. Copyright extends to the performance in public of protected works such as plays, music and records. The recommendations of the Copyright Committee to which you referred are that these rights be perpetuated, and I assume that all your readers will be in general agreement with this; neither the Editor, nor contributors to *Wireless World* would like to see their articles reprinted freely in other journals without acknowledgment or remuneration. The use of tape recorders and the like to record in the home the output of a radio set seems such a glaring example of copying of the work being broadcast from the radio station that one can think of no legal ground on which to defend it if the broadcast material is *itself in copyright*, such as a modern play, a musical composition, a lecture, or a gramophone record. If the home recordist has not obtained permission from the owner of the copyright he will be offending the law as it has been known for many years.

So much for the act of making a copy of a work in copyright.

The Committee has suggested (in para. 117) that a right be given to a broadcasting authority "to control any subsequent copying of its programmes by any means" and this would "extend to prevent the mechanical recording of a broadcast of material which is non-copyright"—as well as of copyright material. If this recommendation becomes law then the recording on a tape recorder of a work out of copyright would be illegal.

Now Section 2 of the Act of 1911 deals with "Fair Dealing" in which it is declared that fair dealing with any work for the purpose of private study, research, criticism, etc., shall not constitute an infringement of copyright—and no change to this has been suggested by the Committee. This apparently means (and I say apparently, because although I was a member of the Committee I am not a lawyer and cannot write authoritatively) that if you record at home for the purpose of private study or criticism such recording could be regarded as fair dealing. But the greatest care must be exercised in interpreting the word "private"; what constitutes "public" is referred to at length in para. 125 of the Report: "it seems to us wise to assume that unless a performance takes place in a *purely domestic* setting the probability is that it will be regarded by the courts as taking place in public." Certainly local radio societies, music clubs and the like are almost certain to be regarded as "public" so that the playing of a tape recording of the broadcast of a copyright work before such a society or club would be outside the domestic circle.

I have thought a great deal about this subject and cannot see that any other ruling would be fair to authors, composers, lecturers, etc.; what an Englishman does in his home is in his castle, provided the walls are thick enough and that there are no strangers within the gate.

Newbury, Berks.

T. E. ALLIBONE.

Alternative Television Service

MAY I reply to the leading article in your February issue under the above title? Although I find myself in general agreement with your conclusions about the advis-

ability of temporarily leasing B.B.C. transmitters, I think you paint too gloomy a picture of the difficulties and delays to be overcome before an alternative TV programme can be provided.

It was made clear in the B.B.C. debate that it was *not* necessary for the B.B.C. to complete their TV plans. The Assistant Postmaster-General, in winding up the debate on June 11th, 1952, said:

The Government are in earnest, not only over breaking the B.B.C. monopoly, but also in permitting sponsored television. They have decided that the B.B.C. shall be allowed to have priority over the completion of the [construction] programme that was held up because of the capital cuts. That does not mean that when adequate resources of money and materials are available competitive TV must wait until the B.B.C. extension is complete in all respects. It does not mean that the B.B.C. will have to put the last coat of varnish on any building that can be put up before competitive TV can be started.

These words, obviously carefully chosen, were spoken in the last speech before the vote was taken and it was on these words that many of us were able to support the Government. You will notice that there is no reference to a need for further progress on v.h.f.

Your leader stated "the Television Advisory Committee is also charged with the task of advising him [the Postmaster-General] on the conditions for competitive television." As I understand it, there may be some duplication of functions between the T.A.C. and the new "controlling body" mentioned in the White Paper Cmd. 8550. The White Paper says in para. 9: "A controlling body will be required . . . for regulating the conduct of the new stations, for exercising a general oversight of the programmes and for advising on appropriate matters; licences for any new stations would be granted (and if necessary withdrawn) by the Postmaster-General on the advice of this body."

Although there are difficulties to be overcome, I don't think, from the above facts, that these are as formidable as you suggest. However, I do welcome your support for the leasing of the B.B.C. transmitters to get the experiment started and at the same time increase the B.B.C.'s income. In a letter published by the *Observer* on September 18th, 1949, I ventured to suggest:

If in the early years only one TV station is transmitting in an area, we can still have the benefit of competition by dividing the TV hours so that both commercial and national programme sources alternatively feed the same transmitter.

This might provide a temporary expedient, but I hope that it would not delay other people proceeding with their plans to construct their own transmitting facilities, so that the public may not be denied the right of looking at any alternative programme should they so desire.

House of Commons.

C. I. ORR-EWING.

Television Modulation

THE letters from F. C. McLean and E. Green in your February issue discuss the conversion efficiency of the low-level modulation television transmitters now operating at Kirk o' Shotts and Wenvoe. Your correspondents are correct in stating that under peak-white conditions the efficiency of the newer stations is greater than that of Sutton Coldfield or Holme Moss, where high-level modulation is used, but we would stress that this efficiency advantage is maintained at all depths of modulation, and in fact becomes even greater at small modulations corresponding to the average picture. In the older transmitters it is only the final stage that takes a reduced power as the modulation decreases; the power input to the rest of the transmitter remains constant. If low-level modulation is employed, a greater number of stages can be of the variable power input type and two such stages are included at Kirk o' Shotts and Wenvoe, so that there

is a larger reduction in power drawn from the mains as the white-content of the picture falls.

We agree with your correspondents that conversion efficiency is only one criterion of many which must be considered in design; another on which both have commented is the relative floor-area occupied by the two types of transmitter. The newer transmitters also contain the low-tension switchgear which accounts for 40 per cent of the floor area of the Holme Moss transmitter and yet they are smaller by some 100 square feet. We submit that by this reduction in size and the improvement in efficiency a significant step towards overall economy of the service has been taken.

Hayes, Middlesex.

E. McP. LEYTON.

E. A. NIND.

Psycho-Optics in Television

IT is with great interest that I read the article by C. Burns in the January *Wireless World*. I should like to point out that in your February, 1946, number you published a short article of mine entitled "Television Psychology: Is the Large Screen Essential?" which was partly based on the same suppositions and came to the same conclusions as Mr. Burns' contribution.

Berne, Switzerland.

PAUL BELLAC.

IN the article in your January issue the author attempts to explain why a large television screen is "better" than a smaller one, basing his argument on the fact that binocular vision enables the viewer to distinguish between a small screen close by and a large screen further away, whereupon if both appear sharp "the deduction is unconsciously made that the larger picture contains more detail than the smaller."

We are offered no corroborative evidence of this latter statement, which I find a trifle ingenious. Even if it can be proved to be true, it does not logically follow that the author has proved his point. For example, many painters and photographers depend for their effects largely upon sheer size, with no attempt to secure fine detail or even to imply it; in fact such pictures would actually lose in impressiveness if cluttered with detail.

I suggest that the true answer is more subtle than your author supposes. Perhaps other readers may have alternative theories.

Iver, Bucks.

L. S. LEPAGE.

Phase-Angle Ellipse

HAVING read the note in the October issue on the measurement of phase angle, I feel that it may be of interest to give a more general solution which is even less well known. This solution does not require that both deflections should be of the same amplitude.

If the x-deflection is of amplitude E_x and the y-deflection of amplitude E_y and the phase angle between them is θ , it can be shown that

$$\theta = \sin^{-1} \frac{CD}{E_x E_y}$$

where C and D are respectively the major and minor axes of the ellipse as in the original note referred to above. In words: "The ratio of the product of the major and minor axes to the product of the total x- and y- displacements is equal to the sine of the phase difference of the two signals."

Kingswood Warren, Surrey.

G. G. GOURIET.

Signal Tracing

C. H. BROAD'S letter on signal tracing in your January issue is of interest to me since my firm imported the Rider "Chanalyst" Signal Tracer in 1938. Importing ceased on the outbreak of war.

We still have one in our service department which has been switched on all day every working day since 1938, and is still giving excellent service; replacements have been one valve, one coupling condenser and three "magic eyes."

We believe the Rider "Chanalyst" was the first commercial signal tracer to be marketed in this country.

Holiday & Hemmerdinger, Ltd., J. S. HOLIDAY.
Leeds.

Input to Output

READING circuit diagrams from left to right is quite universal in the world of telecommunications. I cannot help feeling that your explanation (p. 21, January issue) is hardly correct and perhaps a little far-fetched.

I have no experience in the Far East, and cannot, therefore, answer for the reactions of Chinese and Japanese engineers. But during my long work with colonial broadcasting operatives in the Middle East, I have never discovered any hesitation on their part to draw or follow diagrams in our style and conception; i.e., beginning with the input on the left and proceeding along the circuitry towards its output on the right of the paper.

And this practice was in no way affected by the fact that the mother tongues of many of my colleagues and staff were being written and read in the oriental style from right to left, as in Arabic, Hebrew and other near-eastern languages.

Great Baddow, Essex.

W. G. POWER.

BREAK-THROUGH IN HEARING AIDS

—And a New Use for Crystal Detectors

ACCORDING to a letter published in *The Silent World*, journal of the National Institute for the Deaf, hearing aids may in certain circumstances be affected by break-through of radio signals. The letter reads:—

One of my colleagues sitting in his South Kensington flat, recently heard a disembodied voice make a number of remarks, among which was a reference to a local road "... Harrington Road ...". For my part, when passing London Airport I have often been disturbed to hear loud "peeps" as though from horns, although no cars have been near. Each of us uses a valve amplifier hearing aid continuously, and the explanations appear to lie in the interception of short-wave radio communications by taxicab fleets and in the interception of airport radar scanning beams. I am able to detect the passage of a rotating radar beam at a distance of 200 yards, and when close up to the reflector, the signal is so strong that a companion can hear the periodic "peeps" coming from my fitted earpiece. Hearing aid manufacturers will need to fit r.f. stoppers in future designs!

Many years ago when trying a pick-up coil in conjunction with a home-made hearing aid for telephone conversations, I received high-quality reproductions of our golden voiced TIM and the two B.B.C. programmes, simultaneously. This prompts me to add that there is undoubtedly a market for plug-in units for our hearing aids, containing simply a tuning system and a modern crystal detector so that we may hear the radio programmes wherever we are. What fun it will be to switch over to "Twenty Questions" when the speakers at our business meetings are unexpectedly dull. Again we will have the advantage of our hearing friends. Already we can switch off, but the future offers us stand-by entertainment as well!

Twickenham.

F. W. CUCKOW.

Mr. Cuckow tells *Wireless World* that, since his letter was written, he has made a broadcast receiver unit for use with his hearing aid. The design of the radio unit closely follows that of the receiver employing a G.E.C. germanium diode described in our September, 1951, issue. Apparently a "random" aerial gives sufficient signal pick-up in the London area, and the 2-circuit tuner of the unit gives enough selectivity.

THE "BELLING-LEE" PAGE

Providing technical information, service and advice in relation to our products and the suppression of electrical interference.

Your T.V. Aerial ! When did you last examine it ?

A letter came in the other day asking for reprints of this page. By way of comment the writer told us that he still has his original "Belling-Lee" T.V. aerial that was erected on October 29th 1938—fourteen years in all weathers and without attention. That is the kind of letter we like to receive. However, we will continue to ask users to take advantage of the protective nature of paint. The cost of an aerial spread over a number of years is not much, but it is a nuisance having to cope with

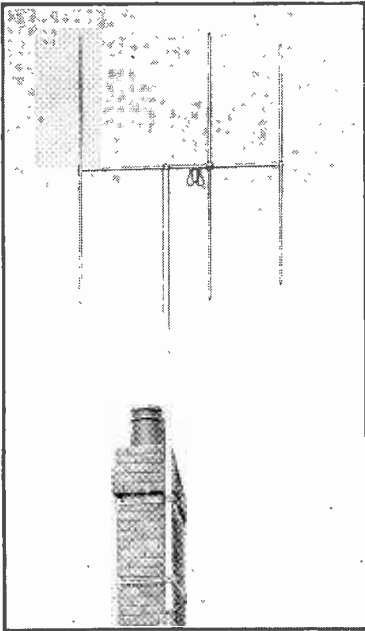

"Belling-Lee" 3-element array.

replacements which generally become necessary at the most inconvenient times. Just think, if your aerial failed on the morning of the Coronation, and you were so located that a good aerial really was necessary. Don't take chances, put up a "Belling-Lee" aerial in the first place, or if you have been disappointed, in the second place; treat it well, treat it to a coat of paint.

Reception in Norfolk

We know of receptions near Dersingham, and supposed most people round this area would look in on Sutton Coldfield, 66 miles away. However, the aerial we are thinking of looks at Holme Moss 108 miles away. It is a "Belling-

Lee" "Junior Multirod" with a mast head pre-amplifier, and results are excellent. Of course the Holme Moss mast is very high and there is low ground for about 80 miles to the north west. The nearest transmitter is not always best.

Mast Head
Pre-amplifier
Unit.



Wenvoe is on the air with full power

We have a monitoring post at a difficult spot near Andover, where we have a really good aerial. First we tried London, 66 miles distance, on 17 K.w., but results were bad. We then changed to Sutton Coldfield, 66 miles on 50 K.w., results were better, but not what we would call real entertainment value. When Wenvoe came on the air with 5 K.w., 80 miles away, the signal was there, and we tried a mast head pre-amplifier, this produced the best results to date; then when Wenvoe came on 50 K.w. it was almost too good. This will surely bring tremendous satisfaction to an enormous number of people situated in what has hitherto been considered almost dead ground.

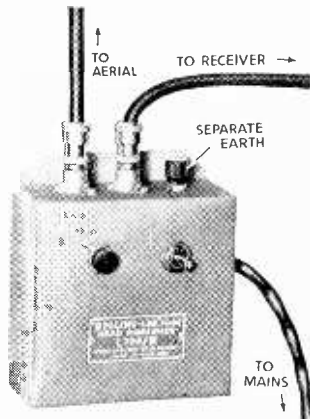

Power Unit.

Channel Conversion and Aerials

Reprinted in its entirety from the "Murphy News", the House Organ of Murphy Radio Limited.

We still come across cases where television receivers have been converted for use on an alternative channel, and results have not been entirely satisfactory because the dealer has not changed the aerial to suit the new transmitter frequency.

In many of these cases the receivers have been working on the fringe of one transmission area, and the conversion brings them into the swamp area of a new transmitter. The first receiver is converted, tried out on the existing aerial and the results are so startlingly good on first tests that the dealer is convinced that all the fuss and bother of converting aerials is unnecessary. Everything goes happily for a week or two. Then it is found that a customer complains of low sound, sound on vision, vision on sound or heterodyne patterns, and by this time the question of aerials has been completely forgotten. So the engineer suspects faulty conversion instructions, outside interference, bad design, or anything but the aerial.

Our worry on this point is not only for the customer who complains; there must be many set owners who are getting sub-standard results from this cause, but are not complaining, simply because they do not know what the performance should be.

We regard this matter as of some importance and we feel that it is a dealer's duty to the customer, when converting a receiver from one channel to another, to change the aerial at the same time.

An interesting thought for Farmers

If farmers with television would take the trouble to suppress all the motor vehicles on the farm, and encourage their regular visitors to suppress their cars, they would then have a most useful indication as to when a strange vehicle was around, because unfortunately, there are still a far greater number of cars that are un-suppressed than suppressed. At least one poultry thief has been caught in this way.

Written 24th January, 1953



MARCONI communication systems



serve mankind

The jungle is no longer the barrier which for so many centuries hampered the progress of communications. Guglielmo Marconi's invention of wireless overcame this obstacle just as it overcame the ocean and the

desert. The Company which he founded is still exploring, in the same exacting way, new ideas and techniques for bringing communications more fully into the service of mankind.



SURVEYED



PLANNED



INSTALLED

MARCONI'S WIRELESS TELEGRAPH COMPANY LTD • CHELMSFORD • ESSEX

WORLD OF WIRELESS

24-Hour Standard-Frequency Transmissions ♦ Belfast
Television Station ♦ F.M. for Amateurs ♦ Show News

Standard Frequencies

FOR the past three years the G.P.O. Rugby Station (MSF) has been radiating an experimental service of standard frequency transmissions under the auspices of the National Physical Laboratory. These transmissions have been for short periods each day and on different frequencies. We learn that it is now planned to introduce a 24-hour service in the near future. These transmissions, which will still be radiated from Rugby but with a reduced power, will be on several of the six internationally agreed carriers for this service, i.e., 2.5, 5, 10, 15, 20 and 25 Mc/s.

The following 15-minute cycle is at present in use during each transmission period and will probably be repeated throughout the 24 hours:— carrier modulated with 1,000 c/s for five minutes, one cycle-per-second timing pulses for five minutes, the carrier unmodulated for four minutes and the call-sign and announcement for one minute.

Our sister journal, *Wireless Engineer*, publishes each month the results of measurements made daily by the N.P.L. on the standard frequency transmissions from Rugby.

Physical Society's Show

ALL the exhibits at this year's show of scientific instruments and apparatus sponsored by the Physical Society will be housed in one building—the Imperial College of Science and Technology, Imperial Institute Road, London, S.W.7.

As already announced, tickets are available from the Society and exhibitors for specific days or morning or evening sessions. The morning of the opening day (April 13th) is reserved for Fellows of the Society and the Press. It will be open daily from 10 a.m. until 8 p.m., except on the last day (April 17th) when it closes at 5 p.m.

The Handbook of the exhibition can be obtained (price 6s or 7s 3d by post) from the Physical Society, 1, Lowther Gardens, Prince Consort Road, London, S.W.7.

N. Ireland Television

A SITE has now been acquired about 2½ miles from the centre of Belfast for the installation of the temporary low-powered television station which will serve the city and its immediate surroundings. The station, which will be known as Glencairn, will share Channel 1

(45 Mc/s vision, 41.5 Mc/s sound) with Alexandra Palace. Transmissions will be horizontally polarized.

The permanent stations at both Belfast and Pontop Pike (Newcastle) will, of course, employ asymmetric side-band transmission. The temporary station at Glencairn, however, was originally to use the double side-band system, but it was subsequently decided to adapt both the mobile transmitters for asymmetric side-band operation.

The Glencairn transmitter will differ from all the others in the B.B.C. service in that it will not be possible for it to operate synchronously as the electricity supply in Northern Ireland is not linked with the mainland grid system. To give manufacturers an opportunity of testing sets asynchronously the B.B.C., at the instigation of the British Radio Equipment Manufacturers' Association, unlocked the Alexandra Palace frame frequency from the mains during the daily test period from January 19th to 23rd.

National Show

THE R.I.C. has confirmed the previously announced provisional dates for the 20th National Radio Show. They are September 1st-12th at Earls Court, London.

Admission on the first day of the show will be limited to holders of invitation tickets and dealers' season tickets; the public will not be admitted on this preview day. It will be open daily from 11 a.m.-10 p.m.

Amateur F.M.

WITHIN a few days of the publication of the list of amateur facilities in our January issue (p. 16) the Post Office announced that as from January 31st British amateurs would be permitted to use frequency modulation (F1, F2 and F3) in six more bands: 1715-2000, 3500-3635, 3685-3800, 7000-7300, 14000-14350 and 21000-21450 kc/s.

The notice stipulates that the carrier frequency must be at least 10 kc/s within the limits of the frequency band in use and that the maximum deviation of carrier frequency must not exceed 2.5 kc/s. The maximum effective modulating frequency is limited to 4 kc/s and the a.f. input to the frequency modulator at any frequency higher than 4 kc/s must not be less than 26 db below the maximum input at lower frequencies.

Higher Technology

IN pursuance of the Government's stated policy of establishing at least one institution of university rank devoted predominantly to the teaching and study of higher technology, it has been decided to develop the Imperial College of Science and Technology (South Kensington). There are at present 1,650 full-time students at the College and it is planned to increase this number to 3,000 during the academic quinquennium 1957-62. This was



THEATRE TELEVISION. Four large screen (4 ft × 3 ft) projectors installed in the Scala Theatre, London, enabled the audience to follow the continuity of the televised stage show and the film sequences inserted at Alexandra Palace. The equipment was installed by Aren.

announced in Parliament on January 29th in response to questions regarding plans for the establishment of a technological university.

T.A.C. Sub-Committee

A TECHNICAL sub-committee of the Television Advisory Committee has been set up under the chairmanship of Dr. W. G. Radley, engineer-in-chief, G.P.O. The other members are: H. Faulkner (G.P.O.); H. Bishop (B.B.C.); R. T. B. Wynn (B.B.C.); P. H. Spagnoletti (B.R.E.M.A.); K. I. Jones (Cossor); B. J. Edwards (Pye); G. M. Wright (Marconi's); Dr. R. L. Smith-Rose (D.S.I.R.) and Professor Willis Jackson (Imperial College).

Radio and the Blind

THE latest radio textbook to be produced in Braille by the National Institute for the Blind is the American "Radio Amateur Handbook." Produced by hand (there will be, therefore, only two copies) the handbook will occupy some 20 volumes.

The N.I.B. Report for 1951-52 records that since the British Wireless for the Blind Fund was started in 1929 nearly 95,000 sets and relay installations have been supplied to blind people in the U.K.

A special research fund has been inaugurated to investigate the various methods of recording in relation to the production of "Talking Books," which at present are recorded on 12in discs at 24 r.p.m.

Indexes

THE index to the 1952 volume of *Wireless World* is now ready and is available from our Publishers, price 1s (postage 2d). Cloth binding cases for the volume are also obtainable, with index, price 6s 5d by post. Our Publishers can also undertake the binding of readers' own issues; the cost including binding case and index being 17s 6d plus 10d postage.

We would also again remind readers of the index to the abstracts and references section of *Wireless Engineer*. This indexes under 18 subject headings some 3,500 articles on radio and allied subjects published in the world's journals during the past year. It is obtainable by post from our Publishers, price 3s 9d.

PERSONALITIES

Professor Willis Jackson, D.Sc., D.Phil., M.I.E.E., who has occupied the Chair of Electrical Engineering at the Imperial College of Science and Technology (London University) since 1946, has accepted the full-time appointment of director of research and education with the Metropolitan-Vickers Electric

tor of research and education will relinquish this post on Professor Willis Jackson's appointment to devote more time to his managerial duties.

Brigadier J. B. Adams, B.A., A.M.I.E.E., is now head of the Telecommunications Department in the London office of the Iraq Petroleum Co. and associated companies. He previously served for over 25 years in the Royal Signals and on his retirement in May, 1952, was Deputy Director of Signals at the War Office.

Dr. Thomas E. Allibone, F.R.S., director of the A.E.I. Research Laboratory at Aldermaston, has been appointed to the board of the Edison Swan Electric Co., which is a member of the A.E.I. Group of companies, as director of research.



(Left)
PROFESSOR WILLIS
JACKSON



(Right)
R. R. C. RANKIN

cal Co. The appointment, which is from next July, carries with it a seat on the board of the company. Professor Jackson, who occupied the Chair of Electrotechnics at Manchester University from 1938-46 was previously with Metrovick as a research engineer. He is a member of the N.P.L. Radio Research Board and the T.A.C. technical sub-committee.

Dr. C. Dannatt, O.B.E., M.I.E.E., who, on his appointment as assistant manager of the Metropolitan-Vickers Electrical Co. in 1951 succeeded Sir Arthur Fleming as the company's direc-

Richard R. C. Rankin, O.B.E., A.M.I.E.E., who a few months ago was appointed technical manager of Mullard, Ltd., and Mullard Equipment, Ltd., and has since become a director of the organization, has also been appointed a director of Telcon Telecommunications, Ltd. (owned jointly by Mullard and the Telegraph Construction and Maintenance Co.). He succeeds Dr. C. F. Bareford who, as announced in our January issue, resigned on his appointment as chief superintendent of the Long Range Weapons Establishment at Woomera, South Australia.

Sidney Webster has been appointed specialist radio representative of the Edison Swan Electric Co., Ltd., in the company's Birmingham District Office. He thus returns to the company he left in 1947 after twenty-two years' service at its valve factory at Brimsdown.

B. C. Fleming-Williams, director of research, A. C. Cossor, Ltd., and K. E. Harris, the company's research manager, are visiting subsidiary companies in the U.S.A. and Canada, and during their two-months' tour will investigate current electronic developments in North America.

O. W. Humphreys, director of the Research Laboratories of the General Electric Co., is touring Australia. During his visit he will lecture to a number of engineering societies, including a joint meeting of the Institution of Radio Engineers and the Institution of Production Engineers.

H. D. Wilson, sales engineer for the past 15 years with the Sifam Electrical Instrument Co. has been appointed to the board of directors. Prior to joining Sifam he was with S. G. Brown, Ltd., and Measuring Instruments (Pullin), Ltd.

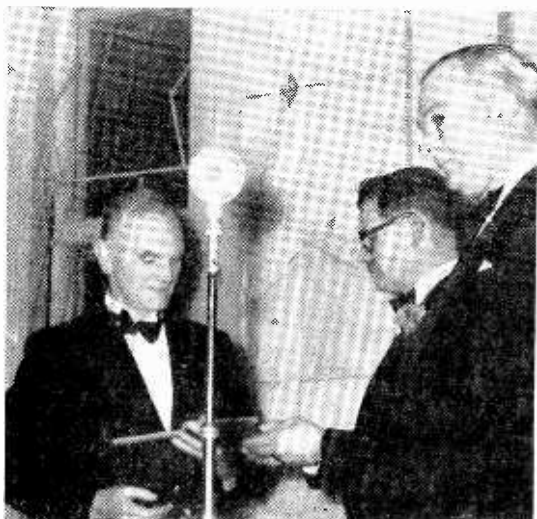

H. S. MACADIE designer of the well-known Avometer, was presented with a gold wrist-watch on completing 25 years' service with the Automatic Coil Winder and Electrical Equipment Co. Mr. Macadie, who is the company's chief instrument engineer, is on the left and Mr. J. H. Rawlings, managing director, is on the right.

Sir Stanley Angwin, K.B.E., is to be the thirty-first recipient of the Faraday Medal (awarded annually by the I.E.E.) "for his outstanding contributions to the development of telecommunications in Great Britain and in the international and intercontinental fields." Sir Stanley, who is at present chairman of the Commonwealth Telecommunications Board, was engineer-in-chief of the Post Office from 1939 to 1947 and chairman of Cable and Wireless from 1947 to 1951. Whilst at the Post Office, which he joined in 1906, he played a major part in the design and construction of the Leafield, Cairo and Rugby radio stations.

Sir Harry Railing, D.Eng., chairman and joint-managing director of the General Electric Company, has been elected an Honorary Member of the I.E.E. "for his services to the electrical engineering profession and to the science; and for his services to the Institution."

OUR AUTHORS

J. M. Carter, author of the article on the design of a magnetic recorder, graduated from Durham University in 1941. For the following five years he was engaged on radio valve development. In 1946 he joined the research staff of Wright and Weaire, Ltd., where he has been engaged principally on magnetic recording research and development.

A. Q. Morton, who describes an oscillator/filter unit on page 129 of this issue, was a wartime trainee of our frequent contributor M. G. Scroggie at an R.A.F. Radio School, where he took the radar course. He went on to T.R.E. to work on OBOE. He is now a minister of the Church of Scotland.

OBITUARY

It is with regret we record the death on January 12th of **H. Leslie Dixon**, aged 79, founder in 1919 of Leslie Dixon and Co., who specialize in the disposal of ex-Government radio and electrical apparatus. The company, which also makes, repairs and calibrates measuring instruments, has been under the management of R. H. Hatfield since the retirement of Mr. Dixon in 1950.

IN BRIEF

Receiving Licences.—An increase of 711,632 television licences during 1952 is recorded by the Post Office, making a total of 1,892,832 at the end of December. There were 10,966,641 sound broadcasting licences—including 172,657 for cars—current at the end of the year, making an overall total of 12,859,473—an increase of 311,773 on the previous year.

Electronics in Nucleonics.—A limited number of physicists and electronic engineers holding a degree or equivalent qualification are invited by the Atomic Energy Research Establishment, Harwell, to attend a course on the design, use and maintenance of electronic instruments in nuclear physics. The course, for which the fee is 12 gns, will be held at the Isotope School, Harwell, from March 16th to 20th. Application forms may be obtained from the Electronics Division, A.E.R.E., Harwell, near Didcot, Berks.

H. F. Measurement.—A conference devoted exclusively to the techniques and problems of high-frequency measurement was held in Washington from January 14th to 16th. The four main sessions of the conference, which was sponsored jointly by the American I.E.E., I.R.E. and the National Bureau of Standards, were devoted to (a) frequency and time, (b) transmission and reception, (c) impedance and (d) power. H. J. Finden, M.I.E.E., of the Plessey Co., read a paper on "Developments in Frequency Synthesis" at this convention. It described a method of generating any single frequency out of a possible 100,000 in the spectrum 1kc/s-100Mc/s locked in terms of a frequency standard.

Graduate and Vacation Apprenticeships at the various establishments of the General Electric Co. and the opportunities for training and experience provided by the Company are outlined in the booklet "The Graduate in the G.E.C." which is obtainable from Magnet House, Kingsway, London, W.C.2.

French Components.—The annual exhibition of French radio components, valves and testing gear, sponsored by the Syndicat des Industries de Pièces Détachées et Accessoires Radioléctriques et Electroniques (SIPARE) and other associations is being held in the Palais des Expositions, Porte de Versailles, Paris XV, from February 27th to March 3rd.

Student Apprenticeships have been introduced by E. K. Cole, Ltd., to provide a more general training than that available under the Company's existing apprenticeship scheme. They are open to present Ekco apprentices of, or over, 18 years of age, and are intended to fit the trainee for an appointment in the engineering works or office.

Institute of Technology, Loughborough College, is the title given to the Engineering and Science Departments of the college, which have been taken over by the Ministry of Education and reorganized as a separate establishment.

Civil Defence Radio.—The first handbook on Civil Defence issued by the Home Office is entitled "Wireless Instructions for Civil Defence" and deals briefly and in simple terms with the setting up of stations and operating procedure. It is obtainable from H.M.S.O. price 6d.

Speed of Radio Waves.—The general assembly of the International Scientific Radio Union (U.R.S.I.) has, as a result of investigations made in recent years by several different methods, recommended that the following value of the velocity of electro-magnetic waves in vacuum be adopted for all scientific work:— 299792 ± 2 km/sec.

Radio Meteorology.—A four-day conference with sessions on such topics as tropospheric radio propagation and radar storm detection and rainfall determination is jointly planned for next November by a number of scientific bodies in America. Further particulars may be obtained from L. G. Cumming, Technical Secretary, Institute of Radio Engineers, 1, East 79 Street, New York City, who is one of the seven members of the steering committee.

C.C.I.R. London Meeting.—The next plenary assembly of the International Radio Consultative Committee (C.C.I.R.), which is the constituent body of the International Telecommunications Union concerned with the study of technical radio questions, will be held in London in September.

Industrial Training.—A new scheme for the further education of employees who are over the age of entry to the normal apprenticeship and part-time day-release schemes has been introduced by E.M.I. Engineering Development, Ltd., at their factory in Wells, Somerset. The employees have been given the opportunity to increase their technical knowledge and obtain professional qualifications by a self-education home-study course of training under the personal supervision of a qualified tutor who makes regular weekly visits to the works. The scheme is being conducted in co-operation with E.M.I. Institutes.

Persian Gulf Communications.—New radio-telephone circuits in the Persian Gulf opened by Cable and Wireless, Ltd., link Bahrein with Muscat and Kuwait, which is also linked with Baghdad by a new W/T circuit.

Receivers for Rhodesia.—Three export broadcast receivers are among the 400 or so exhibits being sent to Bulawayo, Southern Rhodesia, by the British Council for the British Pavilion at the forthcoming Rhodes Centenary Exhibition. They are the Murphy TA192 (4+1-valve 3-waveband a.c. or d.c. superhet), the Pye PE60 (6-valve, 11-waveband a.c. superhet) and the Alba X707 mains-battery portable radiogram.

CONSOLES for the Creed equipment at the new Teleprinting Headquarters of British European Airways in London were supplied by Widney-Dorlec. In the foreground are the two-tier, three-gang transmitters and in the rear the receiving consoles, each accommodating three printing perforators.

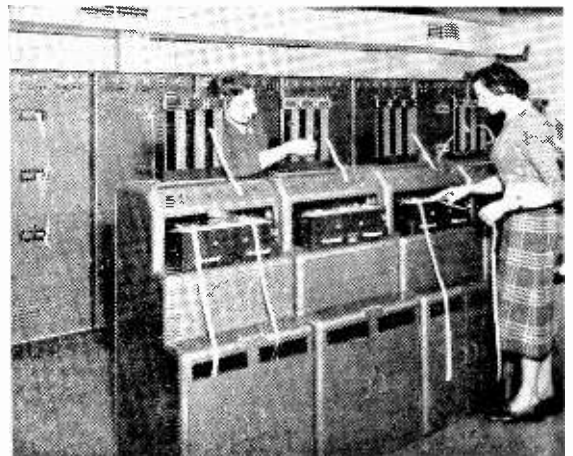

Missing Digit.—The price of the console television cabinet Type 21B was erroneously given as £2 17s 6d in the advertisement of the Winter Trading Co. on page 49 of our February issue. It should be £12 17s 6d.

B.S.I. is to move into new headquarters—British Standards House, 2, Park Street, London, W.1—later in the year. This move will bring under one roof the various sections which are now housed in several buildings. The Institution prepares some 250 new and revised British Standards annually and sells nearly a million copies of them. It, incidentally, convenes some 3,800 committee meetings during the course of a year.

School Broadcasting.—New premises have been taken over by the Schools Broadcasting Department of the B.B.C. at 1-1A, Portland Place, opposite Broadcasting House. The new building has five studio suites in addition to offices. Since 1945, school broadcasting has been conducted from Film House, Wardour Street, London, W.1.

R.C.E.E.A.—A new class of membership—associate members—has been introduced by the Radio Communication and Electronic Engineering Association, mainly for manufacturers having a limited interest in the field of radio communication. The member firms constituting the council, re-elected at the annual general meeting on January 23rd, and their representatives are: B.T.H. (V. M. Roberts), E.M.I. (J. S. Carr), G.E.C. (M. M. Macquene), Kelvin and Hughes (C. G. White), Marconi's (F. S. Mockford), Metrovick (L. H. J. Phillips), Mullard (T. E. Goldup), Murphy (K. S. Davies), Plessey (P. D. Canning), Pye (C. O. Stanley), Redifon (B. St. J. Sadler) and Standard Telephones (L. T. Hinton).

B.R.E.M.A.—The annual general meeting of the British Radio Equipment Manufacturers' Association will be held on March 5th at the Savoy Hotel, London.

INDUSTRIAL NEWS

International Aeradio are to install an air traffic control desk at the Armstrong-Whitworth aerodrome at Bitteswell, near Rugby. The facilities provided will include a four-channel radio-telephone control panel and a remote indicator for the Marconi AD200 direction finder. Radio communication equipment being supplied with the desk includes Pye and Marconi v.h.f. transmitters and receivers.

Relay Companies Combine.—It is announced that plans are being made for the integration of the sound and television relay services of British Relay Wireless, Ltd., and Link Sound and Vision Services, which was formed jointly by Pye, Ltd., and Murphy Radio in 1950. The first television relay system of Link Sound & Vision was installed in Gloucester in 1951.

Ekco's Canadian Distributors.—Canadian Aviation Electronics, Ltd., of Montreal, have been appointed by E. K. Cole, Ltd., exclusive distributors in Canada for Ekco radio, television, communications, radar and nucleonic equipment. Canadian Aviation Electronics will assemble and manufacture Ekco products in Canada.

Mullard.—The commercial activities of the three product groups of Mullard's Equipment Division (radio, telephone and general electronics) are now centred at 6, Gate Street, Lincoln's Inn Fields, London, W.C.2 (Tel.: Chancery 8421), under the recently appointed commercial manager, Capt. R. T. Paul. The general manager, J. P. Jeffcock, and his immediate staff remain at the company's head office, Century House, Shaftesbury Avenue, London, W.C.2, to which address all correspondence should continue to be sent.

MEETINGS

Institution of Electrical Engineers

Discussion on "Is the Presentation of Technical Literature Adequate?" Opener Professor M. G. Say, Ph.D., M.Sc., on March 9th.

Discussion on "Use and Abuse of Research," opener S. Whitehead, Ph.D., M.A. on March 30th.

Radio Section.—"The Study of a Magnetic Inverter for Amplification of Low-Input-Power D.C. Signals" by E. H. Frost-Smith, B.A., Ph.D., on March 3rd. (Joint meeting with Measurements Section).

"Low-Level Modulation Vision Transmitters, with special reference to the Kirk o' Shotts and Wenvoe Stations" by E. McP. Leyton, E. A. Nind, B.Sc. (Eng.), and W. S. Percival, B.Sc. (Eng.), on March 11th.

Debate: "That Broadcasting Hours Should be Drastically Curtailed" on March 23rd.

All the above meetings will be held at 5.30 at Savoy Place, London, W.C.2.

East Midland Centre.—"Some Modern Problems in the Field of Technical Education" by D. S. Anderson, Ph.D., B.Sc., at 6.30 on March 24th at the Gas Dept. Demonstration Theatre, Nottingham.

Cambridge Radio Group.—Paper on "Electronic Equipment in Aircraft" at 8.15 on March 17th at the Cavendish Laboratory, Cambridge.

Mersey and North Wales Centre.—"Radio Telemetry" by E. D. Whitehead, M.B.E., and J. Walsh, B.Sc., at 6.30 on March 16th at the Town Hall, Chester.

North-Eastern Radio Group.—"An Improved Scanning Electron Microscope for Opaque Specimens" by D. McMullan, M.A., at 6.15 on March 2nd at King's College, Newcastle-on-Tyne.

North-Western Radio Group.—"A Method of Designing Transistor Trigger Circuits" by Professor F. C. Williams, O.B.E., D.Sc., D.Phil., F.R.S., and G. B. B. Chaplin, M.Sc., at 6.30 on March 18th at the Engineers' Club, Albert Square, Manchester.

South-East Scotland Sub-Centre.—"Modern Trends in Aerial Design" by J. Patterson at 7 on March 18th at Heriot-Watt College, Edinburgh.

South Midland Radio Group.—"Electronic Motor Control" by S. H. Dale at 6 on March 23rd at the James Watt Memorial Institute, Great Charles Street, Birmingham.

Southern Centre.—"Electronic Telephone Exchanges" by T. H. Flowers, M.B.E., B.Sc., at 6.30 on March 4th at the University, Southampton, and at 7.30 on March 18th at R.A.E. Technical College, Farnborough.

"An Investigation into the Mechanism of Magnetic Tape Recording" by P. E. Axon, O.B.E., M.Sc., Ph.D., at 6.30 on March 18th at the South Dorset Technical College, Weymouth.

London Students' Section.—Visit to the Plessey Co., Ltd., Ilford, Essex (Modern Production Methods for Radio Receivers and Equipment) at 2 on March 11th.

British Institution of Radio Engineers

London Section.—A discussion on "The Standardization of Symbols and the arrangement of Electronic Circuit Diagrams" opener L. H. Bainbridge-Bell, M.A., at 6.30 on March 10th at the London School of Hygiene and Tropical Medicine, Keppel Street, London, W.C.1.

Scottish Section.—"Electronics in Nuclear Research" by J. M. Reid (Glasgow University) at 7 on March 5th at the Lecture Theatre, Natural Philosophy Dept., University of Glasgow.

North-Eastern Section.—"Slotted Aerial Design" at 6 on March 11th at the Institute of Mining and Mechanical Engineers, Neville Hall, Westgate Road, Newcastle-on-Tyne.

West Midland Section.—"The Principles of Electronic Computing Machines" by B. V. Bowden, Ph.D., at 7.15 on March 24th at the Wolverhampton and Staffordshire Technical College, Wulfruna Street, Wolverhampton.

British Sound Recording Association

London.—"The Synchronization of Magnetic Tape and Film for the Amateur and Professional" by N. Leevers, B.Sc., and E. W. Berth-Jones, B.Sc., at 7 on March 20th at the Royal Society of Arts, John Adam Street, W.C.2.

Manchester Centre.—Debate: "Musicians versus Technicians" at 7.30 on March 23rd at the Engineers' Club, Albert Square, Manchester. (Joint meeting with the Manchester Gramophone Society.)

Television Society

London.—"Television Aerial Equipment" by N. M. Best (Antiference, Ltd.) at 7 on March 12th at the Cinematograph Exhibitors' Association, 164, Shaftesbury Avenue, London, W.C.2.

Radio Society of Great Britain

"V.H.F. Aerial Developments" by F. Charman, at 6.30 on March 20th at the Institution of Electrical Engineers, Savoy Place, London, W.C.2.

British Kinematograph Society

Television Division.—"The Application of Television for Underwater Use" by G. T. Symington, at 7.15 on March 25th at the Gaiety-British Theatre, Film House, Wardour Street, London, W.1.

Society of Instrument Technology

Scottish Section.—"The Electron Microscope" by A. Sharp at 7 on March 27th at the Royal Technical College, George Street, Glasgow, C.1.

Junior Institution of Engineers

London.—"Electronics in Materials Handling" by L. Landon Goodman, B.Sc., A.M.I.Mech.E., A.M.I.E.E., at 7 on February 27th at Townsend House, Greycote Place, London, S.W.1.

Institution of Electronics

North-Western Branch.—"Recent Advances in Understanding Semi-Conductors and their Application for Rectifier and Transistor Operation" by Dr. J. S. Blakemore (Standard Telecommunication Laboratories), on February 27th.

"Modern Developments in the Technique of High Vacuum Measurements" by J. Blears, B.Sc. (Metropolitan-Vickers Electrical Co.), on March 27th.

Both meetings will be held at 7 at the College of Technology, Manchester.

Synthetic Radar Trainer

Electro-mechanical Equipment for Simulating Flight Paths of Aircraft

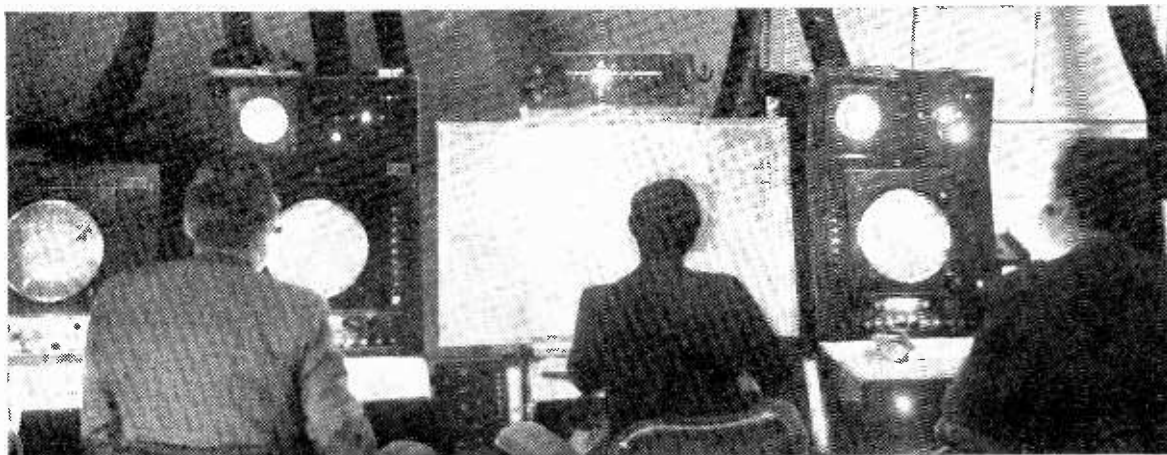

Interior of a part of the radar control room at London Airport.

RADAR is now becoming such an important factor in the handling of air traffic at the larger airports that the adequate training of ground radar control officers in the use of the equipment is becoming a serious problem. The most pressing need is to give the embryo controllers sufficient experience in the correct interpretation of the display shown on the P.P.I. (plan position indicator) cathode ray tube.

The amount of time each trainee can spend on familiarizing himself with the display has hitherto been governed to a large extent by the cost of maintaining aircraft in the air for ground instruction alone, on the availability of aircraft and on weather conditions.

As the handling problems that arise when fast and slow aircraft are mixed—as they are in the vicinity of any large airport—cannot be reproduced by using slow aircraft only for training, some fast types must be employed from time to time, and costs rise alarmingly.

In order to find a solution to some of the mounting problems now being encountered in training ground controllers, the experimental section of the Ministry of Civil Aviation has developed a synthetic radar trainer which will reproduce faithfully the flight paths of aircraft as they would be seen by a modern Surveillance radar.

This new trainer will be used at the M.C.A. Air Traffic Control School at Hurn, and it is estimated to effect a very considerable saving both in time and money. A normal course, for example, which hitherto covered eight weeks, will be reduced to six, and the actual flying hours of aircraft for training purposes will be reduced by 25 per cent, or about 50 hours actual flying time.

Electro-mechanical equipment figures largely in the new trainer. On a rough estimation the trainer is about half mechanical and half electronic, but valves

and circuits are used only where it is not practicable to produce the required “information” for the cathode-ray display tube by mechanical means. The flight path of the simulated aircraft is provided by an electro-mechanical calculator which gives continuous indication of bearing, range and speed in relation to

The three units comprising the new M.C.A. Surveillance radar trainer. Only two of the four bays of the main rack are shown.



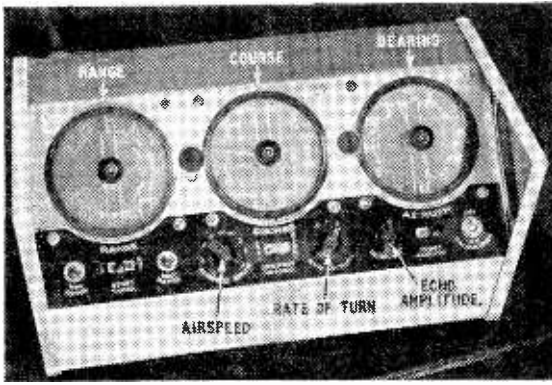

Control unit for "flying" the synthetic aircraft. Dials are standard types used in aircraft and all manoeuvres of a real aircraft can be simulated.

the assumed position of the radar, this being the origin of the radial time base sweep on the tube. It also makes correction for wind on the flight path of the aircraft.

The prototype trainer which was demonstrated recently has provision for providing tracks of up to four aircraft, but it only needs duplication of certain parts to provide almost any desired number of tracks.

As a matter of interest there is in course of development for production by the Marconi Company a radar trainer based on this design and employing the same principles. International Airadio are also interested in the production of a synthetic trainer to the same design and intended for training GCA (ground controlled approach), as well as airways controllers. The basic Marconi trainer will enable two "aircraft" to be flown independently, the flight paths and all other information appearing on the PPI display being exactly as would be seen with a genuine radar. By duplication of certain units 24 independent aircraft tracks can be simulated.

This trainer will be capable of being integrated into any existing radar system, so it will be possible for training purposes to mix synthetic tracks with the genuine for the purpose of studying different handling techniques. Another use would be for Service training, where real aircraft could be used as targets and synthetic aircraft introduced to study interception tactics.

As demonstrated by the M.C.A., the trainer consists of three main units. One is a four-bay Post Office type rack, a part of which is shown in one of the illustrations, the second is a PPI console as used with a genuine radar, and before which the trainee sits, while the third is a small control unit used by the instructor to "fly" the aircraft. Ex-pilots will normally be employed in this rôle. Up to four control units can be employed, but if simple flying manoeuvres only are attempted one pilot-instructor could control them all. With some of the more complicated manoeuvres possible with the equipment each control unit may need individual attention.

The control unit, a close-up of which is shown in one illustration, enables the following information to be passed to its electro-mechanical calculator (the second bay from the left in the rack assembly):—(1) Bearing of aircraft from 0-360 deg; (2) range from 2 to 90 nautical miles, both in relation to the assumed site of the radar; (3) windspeed up to 50 knots; (4) wind direction over 360 deg; (5) aircraft airspeed between 150 and 450 knots, and (6) three rates of turn, or change in direction of aircraft, based on the recognised scale of $\frac{1}{2}$, 1 and 2 in this ascending order.

It is possible also to simulate the following characteristics of a genuine radar:—(a) Amplitude of radar "blip" or echo; (b) radar pulse width from 1 to 5 μ sec; (c) radar beam width from 1 to 5 deg at half-power points; (d) speed of aerial rotation from 0 to 30 r.p.m.; (e) permanent echoes and (f) range markers on c.r. tube.

It is understood the Marconi version of this trainer will provide synthetic air speeds of 150 to 600 knots and a simulated maximum range of 200 nautical miles.

NEWS FROM THE CLUBS

Aberdeen.—The Aberdeen Amateur Radio Society is to issue a certificate to amateurs who contact four member stations of the Society during Coronation year. Also, transmitters in any other Aberdeen will be elected honorary members of the Society. Claims should be sent together with 2s 6d (50 cents Canada, U.S.A. and possessions) to the A.A.R.S., 1-6, Blenheim Lane, Aberdeen, Scotland.

Birmingham.—In addition to the regular general meetings on the second Monday of each month the Birmingham and District Short Wave Society now holds a meeting on the fourth Monday to assist members with technical problems and to give Morse instruction. The Society meets at the Colmore Inn, Church Street, Birmingham. Sec.: A. O. Frearson, 66, Wheelwright Road, Erdington, Birmingham, 24.

Birmingham.—"Radio Fundamentals" is the title of the lecture to be given by W. E. Merrill to the Slade Radio Society on March 6th. On the 20th A. F. Poynton will speak on "Television Tubes, Focusing and Deflection Systems." Meetings are held at 7.45 at the Club Headquarters, The Church House, High Street, Erdington. Sec.: C. N. Smart, 110, Woolmore Road, Erdington, Birmingham, 23.

Brighton.—R. T. Parsons, secretary of the Brighton and District Radio Club (G3EVE), will give his radio autobiography at the club meeting on March 3rd. The club meets at 7.30 each Tuesday at the Eagle Inn, Gloucester Road, Brighton, 1. Sec.: R. T. Parsons, 14, Carlyle Avenue, Brighton.

Cleckheaton.—Dr. G. N. Patchett, who is a frequent contributor to *Wireless World*, will be speaking on "Time Bases and Interlacing" at the meeting of the Spen Valley and District Radio and Television Society on March 11th. A demonstration of colour television will be given by Dr. J. B. Lovatt at the meeting on March 25th. Meetings are held on alternate Wednesdays at 7.30 at the Temperance Hall, Cleckheaton. Sec.: N. Pride, 100, Raikes Lane, Birstall, Nr. Leeds.

Coventry.—The March programme of the Coventry Amateur Radio Society includes a lecture by F. Bowman (G3FAB) on "Applications of Wavemeters" (2nd) and another on "Mathematics" by T. R. Theakston (30th). Meetings are held on alternate Mondays at 7.30 at the Y.W.C.A., Queens Road, Coventry. Sec.: K. Lines, 142, Shorncliff Road, Coventry.

Peterborough.—S. Woodward, secretary of the Peterborough Radio and Scientific Society (G3DQW), will speak about electronics in industry and recent television developments at the meetings on March 5th and 26th, respectively. The subject on the 12th is field direction finding (R. H. Houtby) and on the 19th commercial short-wave receivers (C. J. Guscott, chairman). In addition there is a lecture each week for those wishing to take the Radio Amateurs' Examination. The Society meets at 7.30 at its headquarters in St. Paul's Road. Sec.: S. Woodward, 72, Priory Road, Peterborough.



VORTEXION TAPE RECORDER

FEATURES WORTH NOTING

- ★ Extremely low distortion and background noise, with a frequency response of 50 c/s.-10 Kc/s., plus or minus 1.5 db. A meter is fitted for the measurement of signal level and bias level.
- ★ Sufficient power is available for recording on disc, either direct or from the tape, without additional amplifiers.
- ★ The 15 to 30 ohms microphone balanced line input is fully loaded with 20 microvolts.
- ★ Input 1, which requires 35 millivolts on .5 megohm, is suitable for crystal P.U.s, microphones or radio inputs.
- ★ A power plug is provided for a radio feeder unit, etc. Variable bass and treble controls are fitted for control of the play back signal.
- ★ The power output is 3.5 watts heavily damped by negative feedback and an oval internal speaker is built in for monitoring purposes.
- ★ Facilities are provided for using the amplifier alone and using power output or headphones while recording or to drive additional amplifiers.
- ★ Total power consumption is 53 watts on recording and 48 watts on play back.
- ★ The amplifier, speaker and case, with detachable lid, measures 8½ in. x 22½ in. x 15¾ in. and weighs 31 lbs.
- ★ Price £49, to which weight and cost of Tape Unit, to your choice, must be added.

PRICE, complete with WEARITE TAPE DECK £84 0 0

PRICE, complete with TRUVOX TAPE UNIT £72 2 0

A SPECIAL MODEL IS AVAILABLE FOR TAPE UNITS WITH MONITORING HEADS. BESIDES MONITORING FACILITIES, BEFORE AND AFTER RECORDING, MUSIC, SPEECH OR AN ECHO MAY BE ADDED IF REQUIRED.

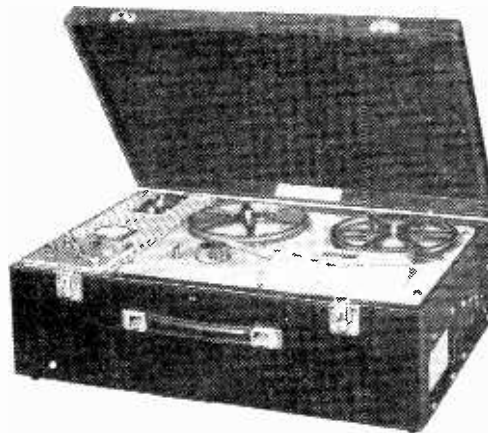

VORTEXION LIMITED

257-261 THE BROADWAY, WIMBLEDON LONDON, S.W.19

Phones : LIBERTY 2814 and 6242-3

Grams : "VORTEXION WIMBLE, LONDON"



For the Radio Industry

SELENIUM
SenTerCel
RECTIFIERS

selenium RECTIFIERS

At any frequency up to 5 Mc/s . . . at any voltage from 0.5 volt upwards to tens of thousands . . . at current ratings from 1 m/A upwards, there is almost certain to be a **SenTerCel Selenium Rectifier** which will do a better, more reliable job.

Why?

Look at these features :

- Considerable saving in weight and space.
- Less wiring.
- Unlimited instantaneous overload.
- Lower heat dissipation.
- No warming-up period.
- Saves the cost of valve-holders.
- Practically indestructible in normal service.
- Imposes no limit to size of reservoir capacitor.
- Low cost.

Please write
for leaflets F/SRL9,
9A, 10 & 11

Standard Telephones and Cables Limited

Registered Office: Connaught House, Aldwych, W.C.2.

RECTIFIER DIVISION: Warwick Road, Boreham Wood, Hertfordshire.

Telephone: Elstree 2401 Telegrams: SenTerCel, Borehamwood.

TRANSISTORS

2—Basic Theory of the Earthed-base Circuit

By THOMAS RODDAM

IN the first part of this article I provided a rather discursive introduction to the transistor: readers who are familiar with the properties of transistors may, even as I write, be complaining that I have told them too little about too much. This month I propose to redress the balance by telling you too much about too little.

There was a time when it was fashionable to argue in these columns about the best equivalent circuit for a valve. There was, though you may not remember this, a time when it was fashionable to argue about the existence of sidebands. We are all more sophisticated nowadays, and I do not expect to see any arguments about the best equivalent for the transistor, though there may be differences of opinion about which is the most convenient. Equivalent circuits are particularly important in transistor circuit design, because there is much more interaction between input and output than there is in a valve, so that a change of load impedance will produce a change of input impedance. Unless you know what you are doing, cascading transistor amplifiers becomes as tricky as cascading tuned-grid, tuned-anode valve amplifiers at 60 Mc/s.

A second problem in amplifier design is the problem of biasing. With a valve we can put a resistance in the cathode circuit, knowing that for d.c. at least it provides negative feedback and thus has a stabilizing effect on the working point. With a transistor in the earthed-base connection we can get the right sign for the bias by putting a resistance in the base connection to earth, but, as I indicated in last month's article, this gives positive feedback. We could decouple, of course, but at d.c. the positive feedback would be there to upset the working point.

First of all, what are we to use as an equivalent circuit? The most general circuit we can use is that shown in Fig. 1. The transistor itself is shown inside the dotted rectangle, with a generator v_G of impedance Z_G connected to the input and a load Z_L connected to the output. The basic network equations may be written down:

$$\begin{aligned} i_1(Z_G + Z_{11}) + i_2 Z_{12} &= v_G \\ i_1 Z_{21} + i_2(Z_{22} + Z_L) &= 0 \end{aligned}$$

From these two equations it is only a question of

ordinary manipulation to work out that the input impedance, looking in at (1), (2), is:

$$Z_{in} = Z_{11} - Z_{12} Z_{21} / (Z_{22} + Z_L)$$

and the output impedance, looking in at (3), (4), is

$$Z_{out} = Z_{22} - Z_{12} Z_{21} / (Z_{11} + Z_G)$$

Notice how Z_L appears in the expression for input impedance, while Z_G appears in the expression for output impedance. Notice also that if we make $Z_L = 0$ the input impedance becomes $(Z_{11} Z_{22} - Z_{12} Z_{21}) / Z_{22}$. We shall see when we have some numbers to put in that this quantity is negative for a point transistor, so that for a short-circuited output the input impedance is negative. Any load capacitance will be such a short circuit at a sufficiently high frequency: our only salvation lies in the fact that the transistor itself will not amplify at very high frequencies.

This equivalent circuit has a very high-class look, and it is, indeed, the sort of four-terminal network you meet in the most superior treatises. It happens, however, to be the network which lends itself most easily to measurement. Let us see how we can perform the measurements.

Suppose that we connect a low impedance generator to terminals (1), (2) and a low-impedance ammeter to terminals (3), (4). We need not calculate the relationship between the input voltage and output current, because the system will be unstable and will oscillate furiously. What we must do is to connect a very high impedance generator to terminals (1), (2), so that we force a current $i_1 = v_G / R_G$

into the circuit, whatever the input impedance may be. The terminals (3), (4), are left open-circuited, but we can apply a voltmeter across either (1), (2), or (3), (4). The open-circuit makes $i_2 = 0$, and we thus find that across terminals (1), (2), there is a voltage $i_1 Z_{11}$ and across terminals (3), (4), a voltage $i_1 Z_{21}$. The process can now be repeated with the current forced in at (3), (4), and we can measure $i_2 Z_{22}$ and $i_2 Z_{12}$. In a typical measuring set for transistors the current used is 100 microamps at a frequency of 5,000 c/s. The ordinary polarizing supplies can be fed in through inductances which do not shunt the impedances to be measured unduly.

It does not take very much consideration to see that any of the Z 's can be expressed in the form

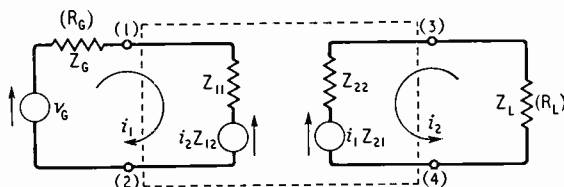

Fig. 1. General form of the equivalent circuit of a transistor, represented as a four-terminal device containing two internal generators connected between a generator and a load.

$Z_{mn} = dV_m/di_n$, with the other current held constant. This means that if we plot a family of curves of V_m against i_n , the slope of any constant current line is the corresponding Z . For the transistor we can get the four sets of curves shown in Fig. 2*, suffixes "e" indicating input or "emitter" and "c" "collector" or output voltages and currents. A typical working point in this set of characteristics might be $I_e = 0.5\text{mA}$, $I_c = -2.0\text{mA}$ giving $V_e = -25$ volts and $V_c = +0.1$ volts. At this point we have, regarding the impedances as resistive, $R_{11} = 800$ ohms, $R_{12} = 300$ ohms, $R_{21} = 60,000$ ohms, $R_{22} = 25,000$ ohms. As you see ($R_{11} R_{22} - R_{12} R_{21}$) is positive at this point, but it is a near thing, and if R_{11} were 700 ohms instead of 800 ohms the quantity in brackets would be negative.

For circuit design purposes it is more convenient to use a transistor equivalent network which contains only one generator. This statement, of course, assumes

*Figs. 2, 3 and 4 of this article are based on Figs. 23, 4 and 7 respectively of the paper "Some Circuit Aspects of the Transistor" by R. M. Ryder and R. J. Kircher, *B.S.T.J.* Vol. xxviii, July 1949.

Fig. 2. Representative static characteristics for the Type A transistor.

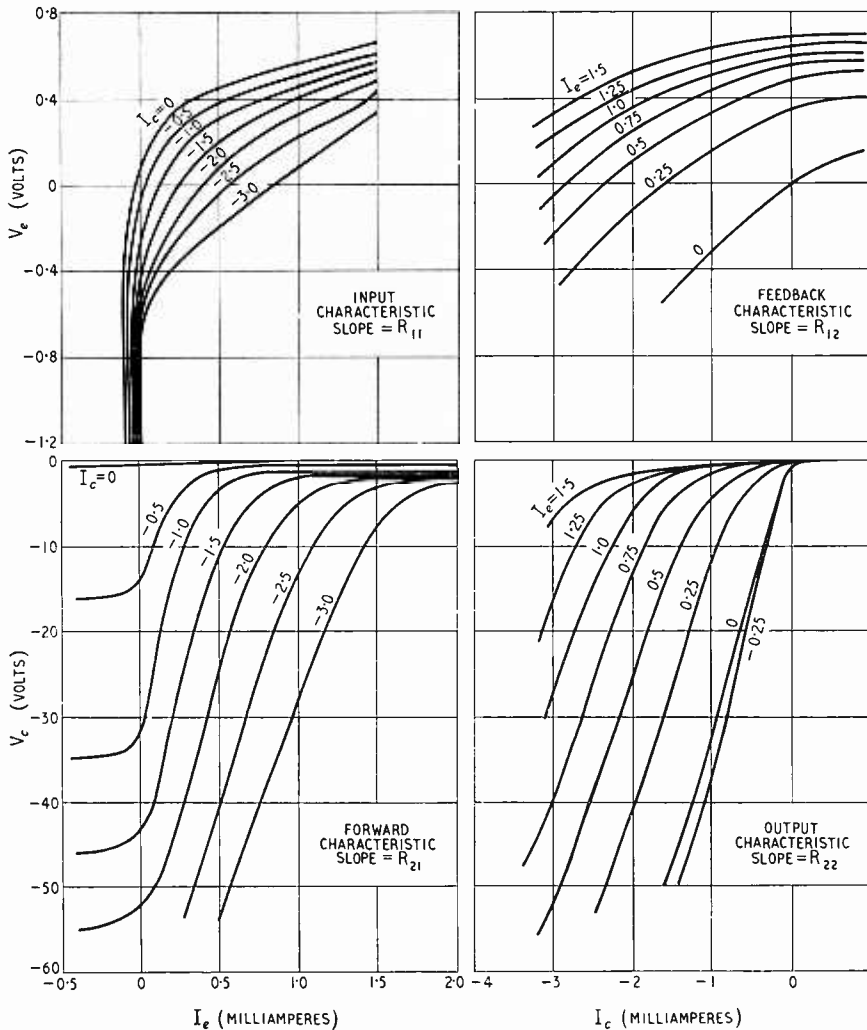

that such a network can be found. There are, in fact, two useful equivalent networks for the point transistor, just as there are for the ordinary valve.†

For the point transistor the two equivalent circuits are those shown in Fig. 3, one of which incorporates a voltage generator $r_m i_c$, the other a current generator αi_e . The first of these is the form which corresponds to a valve equivalent of $g_m e_g$ in parallel with the valve impedance, the second corresponds to the more commonly used valve equivalent of $-\mu e_g$ in series with the impedance. As we must always remember, in designing point transistor circuits, the resistances in valve circuits convert to conductances in transistor circuits, and vice versa. The mutual conductance of a valve becomes the mutual resistance r_m in the transistor circuit, the voltage amplification factor of the valve, μ becomes the current amplification factor α , of the transistor.

If the base resistance r_b is taken as zero, the transistor input impedance in the earthed-base connection becomes just r_e . An ideal transistor would have $r_e = 0$, just as an ideal valve has an infinite input impedance at the grid. A practical transistor has a value of r_e in the region of tens or hundreds of ohms: the users of electrometer valves regard the leakage across the grid-cathode circuit of a standard receiving valve as an equally large deviation from the wanted value.

When r_b is allowed to return to its normal value, the odd hundred ohms or so, there are two effects. Assume first that the collector is open-circuited so far as any signal frequencies are concerned. There will be no collector current, except the standing current, which we are not concerned with. A signal applied to the emitter will drive a current through r_e and r_b in series and since this is the only signal frequency current in the circuit the input impedance will be $(r_e + r_b)$. This is the open-circuit input impedance, which we know to be R_{11} . Now allow some signal current to flow in the collector circuit by connecting a finite load to the collector. The collector

† It is of interest to digress for a moment: the expression "ordinary valve" has at present, a clear meaning, but the transistor is a valve, too. I am undecided whether to go American and use "tube," or whether to adopt a new term, the "free electron valve." This term, however, may suffer in clarity if used by people who lack a R.A.D.A. training, and we shall hear voices saying "three electron" valve, or "free electrode" valve. Then where shall we be?

current loop is also closed through r_b , so that r_b acts as a coupling resistance between output and input, and the input impedance is altered. We shall do the mathematics of this later.

We can repeat the process at the collector. With an infinite input impedance we can look in at the collector and see r_c in series with r_b , giving $(r_c + r_b)$, or R_{22} . When the emitter circuit is connected through a finite impedance, however, the current through the collector path divides between r_b and the path containing r_e . Any current in r_e , however, is a term i_e , which produces a voltage $r_m i_e$ in series with r_c . The amount of current in the collector path thus depends on the way the collector current divides between the r_b path and the r_e path, and this depends on the external impedance in the emitter circuit.

Various theoretical solutions are possible, one of which is to put in symbols for the two external resistances and calculate the conditions for maximum gain. This particular approach leads with great speed to the conclusion that you can get infinite gain, which is useful for oscillators, but not so good for amplifiers. The problem in practice is complicated further by the fact that these r 's which look so simple in the diagrams, are by no means constant. In consequence, the process of design becomes in some ways more simple, in some ways more complicated.

The design of the collector circuit is quite simple. We take the collector voltage-current characteristics, the ones with emitter current as a parameter. On these we lay off a load line, just as we should if we were dealing with a valve. With point transistors we shall usually take a collector load of about 5 to 20 k Ω , the sort of value, indeed, that we take for most triodes. This will fix the working point, of course. On the emitter side we have a different problem. We could take the open-circuit impedance at the emitter as the load to which we match our generator. This gives quite good gain conditions. Unfortunately our signal source will be a voltage generator in series with a resistance, assumed now to be about equal to the load provided by the emitter circuit of the transistor. Roughly, then, the emitter current is $i_e = v_g / [R_G + (r_e + r_b)]$. The output will be a faithfully amplified version of i_e , but since $(r_e + r_b)$ is not constant, but varies over the cycle, and since R_G is not enough to swamp this, i_e is not the simple sine wave that v_g is. In fact i_e is quite distorted, and the distorted i_e is amplified and appears in the collector load.

A first step towards dealing with this difficulty is to make R_G very much bigger than $(r_e + r_b)$. We can do this by introducing an input transformer with a good step-up, just as we sometimes step down to a grid which is driven into the positive grid region. This will mean that there is a wide mismatch between the generator and the amplifier input. Suppose, for example, that $(r_e + r_b) = 250$ ohms, and we have a microphone of impedance 250 ohms at source. A 1 : 1 transformer would match the microphone to the emitter, neglecting feedback effects, but the distortion would be intolerable. We then use a 1 : 3.1 step up transformer, so that the microphone equivalent generator sees 275 ohms instead of 500, but only 25 ohms instead of 250 ohms is non-linear. We shall lose some decibels in gain: not very many, because the microphone will deliver 500/275 times the current, which will be stepped down 3 times in the transformer, so the emitter current is about 2/3 of what it would have been, a loss of 4 db. The only trouble is that the microphone is now mismatched, and it may not like

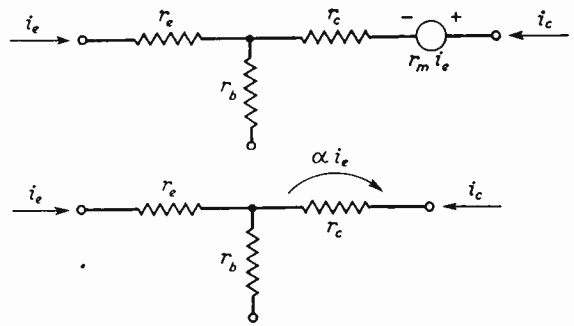

Fig. 3. The two most useful equivalent circuits for the point transistor are these, which contain only one generator.

this. We can add 225 ohms in series on the input side of the transformer, or 2,250 ohms in series on the emitter side, and we shall then be facing the microphone with 250 ohms, while the emitter current is linearized by the large total series resistance.

The numbers I have used here are quite fanciful. It is a matter of individual design to choose how far you will go with this linearization, and at present it does not seem profitable to try to calculate the amount needed. I am inclined to think that this method will be used less and less as transistors get cheaper and more plentiful, because the use of negative feedback for linearization is much better, and for this we need all the stage gain we can get.

One more point remains to be checked before going on to construct a single-stage amplifier based on this design process. We must use an equation which I shall derive later to check that the stage is stable. This equation settles the minimum collector and emitter impedances which are needed to prevent the base feedback producing instability. If it is found that the feedback is too great, either the emitter impedance or the collector impedance must be increased.

Experimental Precautions

Having determined the load line and the working points, and decided on a suitable input impedance transformation, the remaining point is to consider how the working point is to be fixed in practice. For the beginner there can be only one answer: supplies of about +100 V and -100 V should be used, and the appropriate large series resistors added to make them into approximately constant-current sources. Thus if the working point is -20 V, 4 mA at the collector and 2 mA at the emitter, we should take a 20-k Ω resistor in the collector lead and a 50-k Ω resistor in the emitter lead, and apply -100 V to the collector supply resistor and +100 V to the emitter supply resistor. Assuming that input and output transformers are used, we should decouple these resistors in the usual way.

It will be clear from what we have said that if we are taking 4 mA in the collector circuit we must have 4 mA divided between emitter and base. We want, in our arbitrary example, 2 mA to flow in the emitter circuit and 2 mA in the base. If we examine the emitter current-voltage characteristic, with collector current as a parameter, we can find the emitter voltage needed for this bias current. Suppose, for example, that we see we need -0.1 volts on the emitter. A resistance

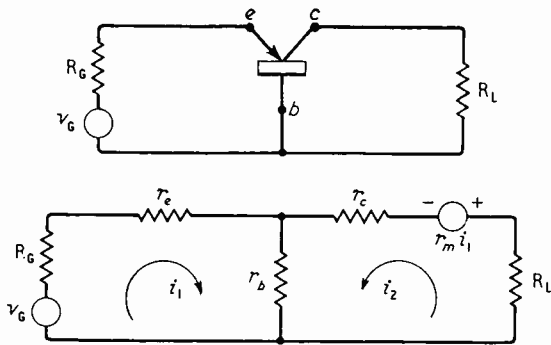

Fig. 4. Earthed-base transistor amplifier and its equivalent circuit.

inserted in the emitter lead will make the emitter more negative, and a value of 50 ohms would be enough to bring the emitter to the desired bias point. Very often, however, we find that we need +0.1 volt on the emitter. This is the same as making the base 0.1 volts negative with respect to emitter. The base current, $i_c - i_e$ is $4 - 2 = 2$ mA so that a 50-ohm resistor in the base lead will fix the bias where we want it. Unfortunately, as we have already indicated, the addition of resistance in the base circuit increases the positive feedback. We can decouple this external resistance in the base by means of a suitably large capacitor across it, but the positive feedback will be present at the lowest frequencies. The effect of this is that differences in d.c. characteristics between transistors are accentuated, just as differences in the d.c. characteristics of valves are reduced by the use of cathode bias resistors. If a transistor is to be driven up to its maximum capabilities, the working point must be chosen very carefully, and base biasing is then out of the question. When we turn later to the problems of *n-p-n* circuits we shall see that there are some compromise solutions which offer the advantages of emitter biasing without requiring two supply voltages of different polarities.

We must now deal rather more formally with the behaviour of the equivalent network. The circuit is shown in Fig. 4, and we can write down at once the two equations:

$$i_1(R_G + r_e + r_b) + i_2 r_b = v_G$$

$$i_1(r_b + r_m) + i_2(r_b + r_c + R_L) = v_L$$

It is now a matter of straightforward algebra to carry out the various calculations. We can put $v_L = 0$ and solve the two equations for i_1 and thus obtain i_1/v_G which is equal to R_G plus the input impedance. Similarly we can put $v_G = 0$ and solve for i_2 thus obtaining the output impedance. The results are:

Input impedance:

$$R_{11} = r_e + r_b - \frac{r_b(r_b + r_m)}{R_L + r_c + r_b}$$

Output impedance:

$$R_{22} = r_c + r_b - \frac{r_b(r_b + r_m)}{R_G + r_e + r_b}$$

Notice that R_{11} , the collector load resistance, appears in the expression for input impedance, while R_G , the emitter lead resistance, appears in the expression for output impedance.

Now consider the conditions for stability. The equivalent input circuit is v_G in series with R_G and R_{11} , a

total resistance of $R_G + R_{11} = R_G + r_e + r_b - r_b(r_b + r_m)/(R_L + r_c + r_b)$. This will only be positive if $(R_G + r_e + r_b)(R_L + r_c + r_b) > r_b(r_b + r_m)$, so that this is the condition for stability. The same result is obtained, as you might expect, by considering the output loop. Following established practice we can write $(R_G + r_e)$, the total emitter lead resistance, as R_E ; $(R_L + r_c)$, the total collector lead resistance, as R_C ; and r_b with any external base resistance, as R_B and the stability condition can then be converted to

$$\frac{r_m}{R_C} < 1 + \frac{R_E}{R_B} + \frac{R_E}{R_C}$$

It is this stability criterion which was mentioned earlier in the article, the application of which is the final stage in the design process.

Further manipulation of the two equations gives the power gain as

$$G_0 = 4R_G R_L \left[\frac{-(r_b + r_m)}{(R_G + r_e + r_b)(R_L + r_c + r_b) - r_b(r_b + r_m)} \right]^2$$

As might be expected, this goes to infinity if the stability inequality becomes an equality. Otherwise it is a pretty cumbersome expression, and its chief value seems to be for comparison purposes with other circuit arrangements.

There are two points which may be discussed here. The first is that it is of great importance to notice that there is no phase shift in the transistor in the earthed-base connection. If the emitter is driven positive, the collector goes positive (less negative). The 180-degree phase shift of the ordinary valve is not obtained. In circuits using feedback, both negative and positive (oscillators!) this point is of course vitally important. The second point is that you will often find the earthed-base point transistor circuit compared to an earthed-grid valve. The earthed-base point transistor circuit has low input impedance—so has the earthed-grid valve. Both have high output impedances, both have input and output in phase. This analogy is a very tempting one, but so far I can judge from my own experience it is a thorough nuisance. The use of the duality principle seems to lead to much wider flexibility in the design of transistor circuits. In a later article I hope to discuss this question much more fully.

It will be obvious to the reader that if the earthed-grid analogy is plausible, we could apply a signal to the base, and take the output from the collector, hoping to get an analogy for the usual earthed-cathode valve circuit, or put the input on the base and take the output from the emitter in a sort of cathode-follower circuit. Both these circuits are quite possible, and in the next article I shall discuss them.

MARINE RADIO CAREERS

IT may not be known, generally, that full-time students at wireless schools who at the time of registration for National Service are training for the P.M.G.'s Certificates in Wireless Telegraphy may have their call-up deferred. Employment in the Merchant Navy does not, however, count as National Service, and men remain liable for call-up to the age of 26, but under the present arrangements members of the Service are not being called up.

The training and service conditions of marine radio officers are outlined in the brochure "Concerning a Career," produced by the Marconi International Marine Communication Company in co-operation with Siemens Bros. and Co. Copies of the booklet and further details of the Service are obtainable from Marconi House, Strand, London, W.C.2.

Oscillator/Filter Unit

A Versatile Instrument for the Experimenter

By A. Q. MORTON

THE circuit upon which this unit is based is one which was developed in the United States, where the instruments are generally named and labelled with a particular application in mind.* Two double triodes of a type easily available as surplus are used in the circuit. One valve is a phase shifter in which any audio frequency within a range of about 100 : 1 is shifted 180 degrees; the valve is used as an output stage and separate amplifier, and, depending on the connections, the instrument will be an oscillator or rejector at the chosen frequency.

The nucleus of the instrument is the phase shifter shown in Fig. 1 (a). A push-pull input is applied across two equal resistors R_1 and R_2 ; a capacitor and a variable resistor are in series across the same input. The point c is always at zero potential, it is connected by equal resistances to two points at equal and opposite potentials. An output across $c-d$ will vary with the impedances of C and R_3 . When these are equal the state is that shown in the vector diagram of Fig. 1 (b). The output is half the input and is 90 degrees out of phase with it. R_3 can therefore be varied to select any frequency to undergo the change of phase without change in amplitude.

In practice two stages are used to obtain a 180-degree shift and the variable resistors are ganged. It is not necessary for them to be accurately in step. R_1 and R_2 are made the anode and cathode loads of a valve, the push-pull input is then provided without complication, and the low values of resistor make it easier to avoid shunting effects, especially as the simple expedient of doubling the resistors of the second stage will enable it to be directly coupled.

An output stage follows to isolate the phase shift network and make good the loss of gain.

* "The Selectoject," by O. G. Villard and D. K. Weaver, Q.S.T., Nov. 1949, p.11.

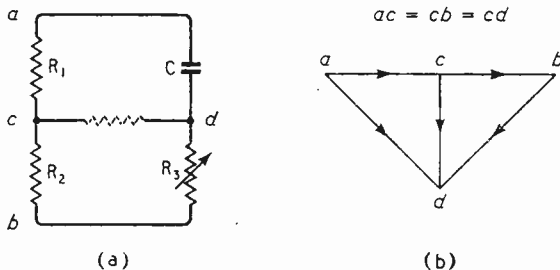

Above: Fig. 1. (a) Basic phase-shift network, and (b) one method of representing the phase relationships when the impedance of $C = R_3$.

Right: Fig. 2. Reversal of the amplifier connections converts the unit from oscillator to filter.

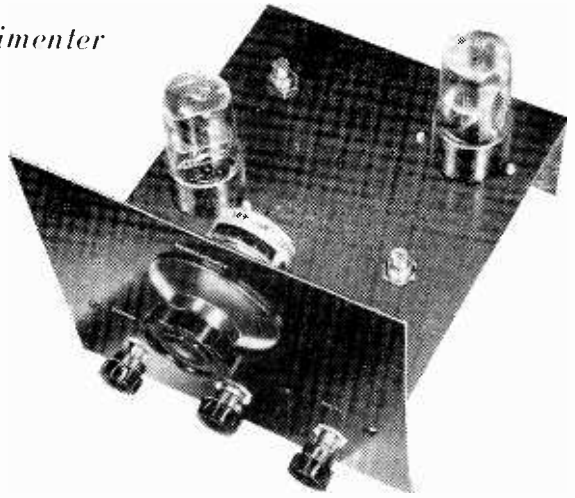

The main control is of frequency and is coupled to the ganged resistors R_1 and R_7 . Subsidiary controls are (left to right) attenuator (R_{15}), oscillator/filter switch and gain control (R_{10}). Pre-set resistor screws project through the base.

The second double triode has provided another amplifier and gives the choice illustrated in the block diagram Fig. 2. If the output of the shifter is fed back to the input to give negative feedback this will take place at all frequencies except that selected for the 180-degree shift. For this frequency the feedback will be positive, and if the gain is over 4 times, oscillation will take place. If the amplifier and phase shift input and output are paralleled, then at the selected frequency cancellation will take place and the instrument becomes a filter, for example, a whistle suppressor.

The performance of the instrument depends mainly on the balance of the phase-splitter stages. A half-watt, high-stability resistor makes a good anode load, and a fair performance is obtained if the cathode resistor is a similar type within 1 per cent of equality. It is better, and not much more expensive, to use a wire-wound resistor of the screwdriver-adjustable type, and, having matched them by a d.c. measurement,

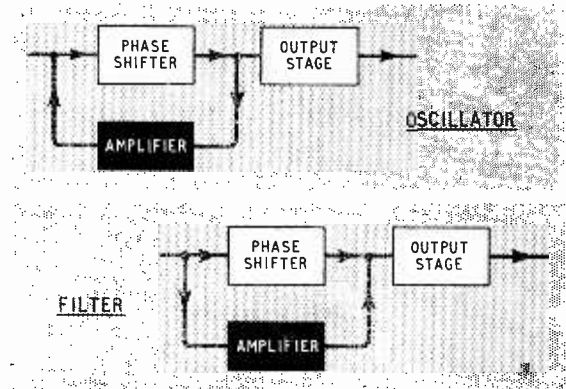

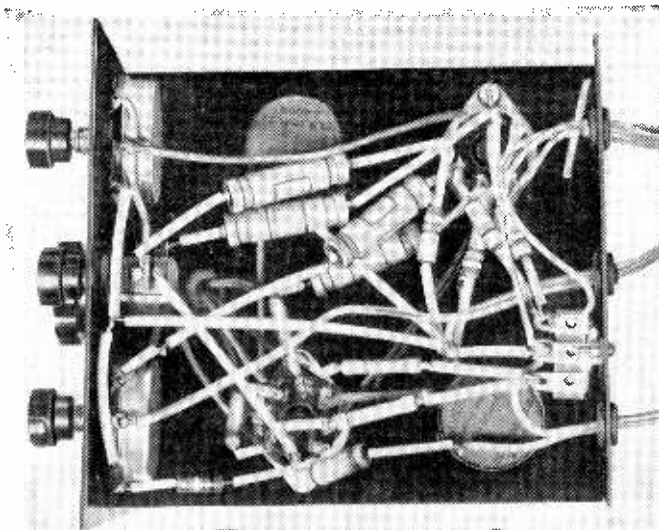

Underside of chassis. In this version, pre-set wire-wound resistors are used for R_2 and R_5 .

to try slight variation at the high-frequency end of the scale.

The range depends on the ratio of maximum to minimum resistance of the two sections of the main control. Using a standard carbon track this should not be less than 100 : 1 and is often 120 : 1. A linear scale is given by a linear-law resistor. For some uses, e.g., as an oscillator, a log scale is more convenient, but for use as a whistle filter the linear law is likely to be easier to adjust. With the values shown the coverage should be 90-9,000 c/s.

Fig. 3. Circuit diagram of oscillator/filter unit. With the component values shown, the frequency range is 90-9,000 c/s. approx.

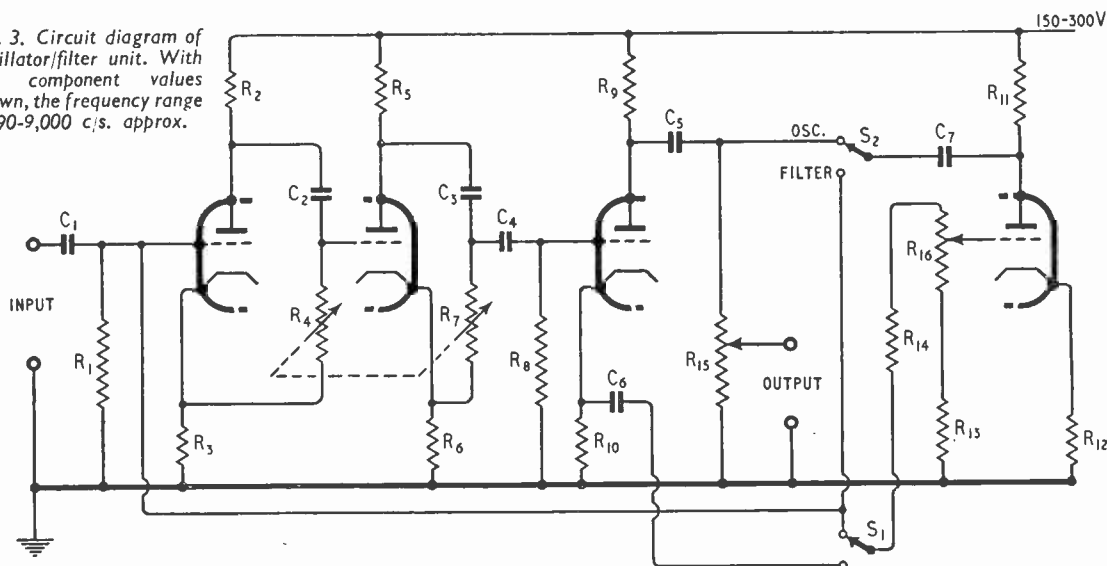

LIST OF COMPONENTS

R_1 1 M Ω , $\frac{1}{2}$ W, 20 per cent.
 R_2 1 k Ω , $\frac{1}{2}$ W, high-stability.
 R_3 Either as R_2 , to match within 1 per cent, or pre-set control.
 R_4, R_7 Two-gang 0.5 M Ω , carbon.
 R_5 2.2 k Ω , $\frac{1}{2}$ W, high-stability.
 R_6 To match R_5 , as above.

R_8 5 M Ω , $\frac{1}{2}$ W, 20 per cent.
 R_9 47 k Ω , $\frac{1}{2}$ W, 20 per cent.
 R_{10} 2.2 k Ω , $\frac{1}{2}$ W, 20 per cent.
 R_{11} 47 k Ω , $\frac{1}{2}$ W, 20 per cent.
 R_{12} 2.2 k Ω , $\frac{1}{2}$ W, 20 per cent.
 R_{13} 10 k Ω , $\frac{1}{2}$ W, 20 per cent.
 R_{14} 15 k Ω , $\frac{1}{2}$ W, 20 per cent.

R_{15} 100 k Ω , variable output control.
 R_{16} 25 k Ω , variable gain.
 C_1, C_4, C_5, C_6, C_7 , 0.01 μ F, 350 V, 20 per cent.
 C_2, C_3 , 2,700 pF, 5 per cent.
 S_1, S_2 Double-pole, double-throw switch.
 Valves Two 6SL7.

As an oscillator the performance is surprisingly good. If the control is set so that oscillation is just established, the amplitude variation will not exceed 1.5 db over the range, and harmonic distortion will not exceed 1 per cent. Before the onset of oscillation the amplifier is highly selective, the rejection of second harmonic in bridge use is at least 40 db.

As a rejector the performance depends to a large extent on the operator. With careful setting the rejection is superior to most "twin-T" networks.

The real attraction of this instrument is its remarkable simplicity and flexibility. Attempts to add refinements are not always successful. For example, switching-in additional capacitors will not extend the range of the control, for the added stray capacity will destroy the balance earlier, and the only effect is to shift the scale. The phase shifters can be used as a source of quadrature voltage for the generation of polar time bases, but for any degree of accuracy the ganged resistors will need to be in step. This demands a better resistor, and a happier solution is to incorporate a phase shifter in the time base.

Of the possible uses a few may be mentioned. It makes a general purpose audio oscillator; it is a convenient source for bridge work and can also be used as a selective amplifier before the detector; it will make an excellent whistle filter or resonance suppressor in radio or gramophone service. As a bandpass or bandstop filter of variable centre frequency and bandwidth it is handy in intermodulation testing, and as an adjunct to a communication receiver it can be used to boost a weak c.w. signal above prevailing background noise or to reject an unwanted one.

The Emicorda

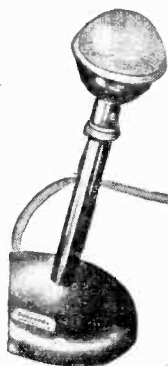

accepted by experts as the highest

achievement in tape recorder performance

—designed and built by E.M.I.

(H.M.V., MARCONIPHONE, COLUMBIA)



The Emicorda incorporates the unrivalled knowledge and experience of over half a century of research in sound recording.

The Emicorda — a recorder and reproducer giving the true-to-life qualities of the original performance— maintains the high professional standards so long associated with other E.M.I. products bearing famous names like H.M.V., Marconiphone and Columbia. The Emicorda can be offered to the public on easy terms and is backed by a nation-wide service organisation.

—POST THIS COUPON TODAY—

Please send me your fully informative leaflet on the Emicorda, together with trading terms.

NAME

ADDRESS

.....

.....

E.M.I. SALES & SERVICE LTD



DOMESTIC RECORDING
EQUIPMENT DIVISION
HAYES, MIDDLESEX
Telephone: SOUTHALL 2468

GAS-TIGHT HYPERLOY A.F. TRANSFORMERS AND CHOKES

The widely-used HYPERLOY range of over 100 Specifications is now available in hermetically-sealed containers, capable of withstanding the most rigorous climatic conditions.

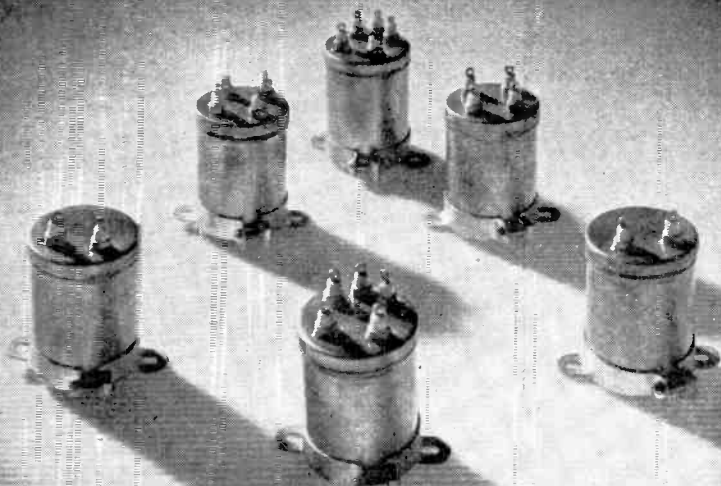

Also available in a major gas-tight containers, a series of bi-limboid Transformers having balanced -um-cancelling windings for use in situations demanding the lowest hum-levels without recourse to expensive mumetal screens.

WRIGHT & WEARITE LTD

138 SLOANE STREET

LONDON, S.W.1.

SLane 2214-5



THE WESTON E772 Super Sensitive Analyser

No 10. Multi-Range Testing Instruments

Best known of all instruments for the testing and servicing of radio and television equipment is undoubtedly the Weston Model E.772 Analyser, a first-class portable instrument with a sensitivity of 20,000 ohms per volt on all D.C. ranges and 1,000 ohms per volt on all A.C. ranges. The additional features of wide range coverage, robust construction and simplicity in operation contribute toward making the E.772 ideal also for laboratory and research work. Full details of this instrument and also of the Model S.75—a Test Set covering 53 ranges—will gladly be supplied on request.

SANGAMO WESTON LIMITED • ENFIELD, MIDDLESEX

TELEPHONE: ENFIELD 3434 (6 lines) and 1242 (4 lines).

GRAMS: SANWEST, ENFIELD

Branches:	London Office:	George:	Court, New	Oxford Street, W.C.1.	Telephone:	CHAncery		
GLASGOW	MANCHESTER	NEWCASTLE	LIVERPOOL	WOLVERHAMPTON	BRISTOL	SOUTHAMPTON		BRIGHTON
Central	Central	Newcastle	Central	Wolverhampton	Bristol	Southampton		Brighton
6208	7904	26867	0230	21912	42403	3328		28497

ATTENUATORS

By "CATHODE RAY"

Keeping them Matched to the Source and the Load

ONE of the minor curiosities of our technical language is that when the thing shown in Fig. 1 is incorporated in a mass-produced receiver it is called a *volume control* but when it is in a signal generator it is dignified by the name *attenuator*. Incidentally, it is also commonly called a potentiometer, though this is really the name for an elaborate piece of apparatus used in standardizing laboratories and likely to cost a hundred pounds or more. Realizing this, the people who are careful with their words call Fig. 1 a *potential divider*; but unfortunately, for some inscrutable reason, this term is usually understood to refer to combinations of *fixed* resistors. It is all very muddling.

BS.204 ("Glossary of Terms used in Telecommunication") defines an attenuator as:

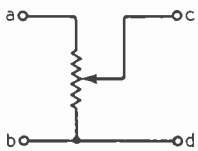

Fig. 1. Is it or is it not an attenuator?

"A network designed for insertion in a line, or between other networks, to introduce a variable loss without introducing distortion or change of impedance."

And if you ask, "What about fixed attenuators?" the answer is in the next definition:

"Pad: A network designed to introduce a fixed loss and also

used between two lines of equal or unequal impedances."

This, I feel, is not as well worded as it might have been; among other things, the significance of the "and also used" is not too clear. To avoid having to say "attenuator or pad" every time I am going to use "attenuator" to include both fixed and variable "lossers."

Elsewhere in BS.204 "loss" is defined as a decrease in power, so it looks as if Fig. 1 has to renounce all claim to official recognition as an attenuator, for it is on the horns of a dilemma. If it works into an open circuit, it introduces a loss of voltage, not power; and if it works into anything that accepts power it cannot vary the power without varying its input impedance. In radio practice, it is most often used to control signal *voltage*, terminal *c* being connected to the grid of a valve so as to supply negligible current. I suppose the combination of volume-control and valve might come within the definition of attenuator, unless it is objected that all valves introduce distortion, or that a valve is not a network. For the present purposes I will uphold this objection, for I have no desire to have valves brought into the discussion.

Sometimes even in radio one wants to control the power going into some kind of impedance. Evidently what one needs, according to the book, is an attenuator. But if one looks up the literature on attenuators the subject appears very forbidding, with all sorts of strange looking things like coshes and

tanhs flying about—the latter presumably being the last dying gasp following a blow delivered by the former. So the temptation is to stick to the good old pot'meter or volume control. The beauty of it, in its proper functions as a potential divider, is that all one has to do is to choose its resistance to suit the impedance of the source across which it is connected (at *ab* in Fig. 1); then the output voltage is simply proportional to the amount of the resistance tapped off between *cd*.

But if an appreciable load is connected between *cd* two complications arise. The first is that the input impedance (i.e., what the source sees, looking into the terminals *ab*) varies with the setting of the control. (Incidentally, so does the output impedance—what the load sees, looking back into the terminals *cd*—but that is so anyway.) The second complication is that the output is no longer simply proportional to the resistance, but both the amount and the scale-shape depend on the load impedance. This change from the simple linear scale of the open-circuited divider is sometimes used for obtaining a special scale shape without having to have a graded or "tapered" resistance winding. For instance, if a linear variable potential divider (i.e., one in which the resistance between *cd* is directly proportional to the uniform-scale reading) is connected to a load resistance 0.8 times its own full resistance, then if a constant voltage is maintained between *ab* the scale from maximum down to 0.4 times maximum can be divided uniformly into 0 to -10 db without serious error; see Fig. 2. The db scale is reasonably uniform over this range with any load resistance from 0.7R to R,

Fig. 2. A simple potential divider has a practically uniform decibel scale from 0 to -10 if it is used to control the power in a load having 0.8 times its own resistance.

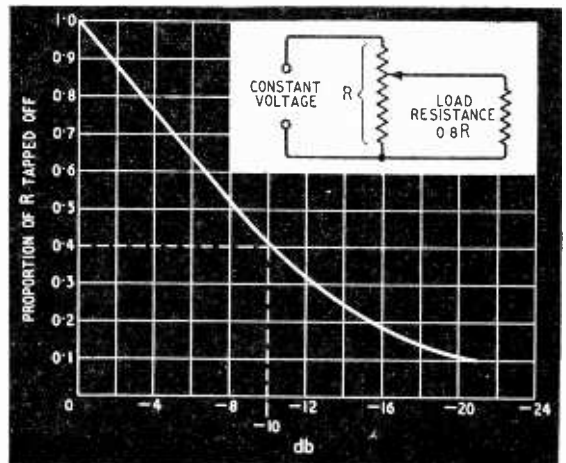

but of course it opens out or closes up slightly as the load resistance is varied. Although this scheme looks very nice on paper, it is not quite so useful as it looks, because the input resistance varies from $0.444R$ to R as the slider is moved from top to bottom, so the input voltage is not likely to remain constant. And of course the output resistance varies vastly.

Results of Mismatching

We radio people don't usually bother a great deal about matching impedances every time we connect anything to anything else. An exception is the output stage of a power valve; the impedance of the loudspeaker or other load has to be reasonably near the optimum specified by the maker of the valve. Now that negative feedback is customary, even that is not quite so critical as it used to be with the early types of power pentode. And for domestic purposes one seldom controls the volume between valve and speaker; controls of volume, gain, or what you will, are nearly always arranged at the inputs of valves, where the impedance problem is dodged.

In sound distribution systems it is another matter; and now with television we are having to consider impedance matching when connecting aerials, feeders, and receivers. But this is nothing to what the line communication people have to do.

Why is impedance matching important? Does it matter if it is not done?

There are several effects of mismatching, not all of which might matter in any particular case. The first effect is a power loss. There is a well-known general rule that the greatest power is delivered to a load when its resistance is equal to the resistance of the source of the power. (I shall stick to simple resistance and not confuse the issue with reactance.) The maximum power thus obtained is half the amount generated; the other half is lost in the source. This

rule includes valves as sources of power, but in valves it is usually overridden by considerations of distortion—which is one reason why I want to leave valves out of it. The point is that if a giver and a receiver of power are connected together, failure to make the input resistance of the giver equal to the output resistance of the receiver—in brief, to match impedances—results in a loss of power transfer; the greater the mismatch, the greater the loss. The actual amount of loss for a given mismatch is shown in Fig. 3; you may be surprised to see that a 2:1 mismatch loses only a fraction of 1 db.

This leads to special complications when the connection is made through a long line. As I explained in the July and August 1950 issues, when power starts to flow along a cable it can't know what the impedance of the load at the far end is going to be, so its rate of flow is determined at first by the "characteristic impedance" of the line itself. If, when the power arrives, it finds the load impedance is wrong, it delivers what it can and takes back what it can't; this being known more officially as reflection. The reflected power is one and the same thing as the power loss due to mismatching, but owing to the distance between source and load we have power travelling in both directions at once. If there is another mismatch at the starting end, reflection occurs there too, and a proportion of the rejected power presents itself at the load a second time, after a delay due to its double journey. This, if an appreciable fraction of the original signal power, would have deplorable results in television, producing one or more "ghosts." Actually, a length of television feeder long enough to produce a time delay that can be seen on the screen usually dissipates sufficient power in itself to reduce such ghosts to the vanishing point, except perhaps if mismatching is altogether excessive. In radar systems, however, reflection effects may be serious unless matching is fairly exact.

But this is getting away from attenuators. To take a practical radio example, suppose one has a $2\frac{1}{2}\text{-}\Omega$ loudspeaker, to be driven from a valve with an optimum load resistance of $5,000\ \Omega$. The usual matching device is a transformer, and the required ratio is $\sqrt{(5,000/2\frac{1}{2})}$ —about 45 to 1. If it were a perfect transformer its primary terminals, with $2\frac{1}{2}\ \Omega$ connected to the secondary, would appear to the valve as a load of $5,000\ \Omega$, so the valve would be at its happiest. To the loudspeaker coil the transformer, with the valve connected to the primary, would look like a valve with an optimum load of $2\frac{1}{2}\ \Omega$; so it would be happy too. Now suppose an attenuator is to be interposed to control the power reaching the speaker. It can be inserted on either primary or secondary side of the transformer, but

Fig. 3. The load resistance (R_L) that receives most power from a given generator is equal to the generator resistance (R_G); the loss is then 50% or 3 db. This graph shows the additional loss when R_L is not equal to R_G .

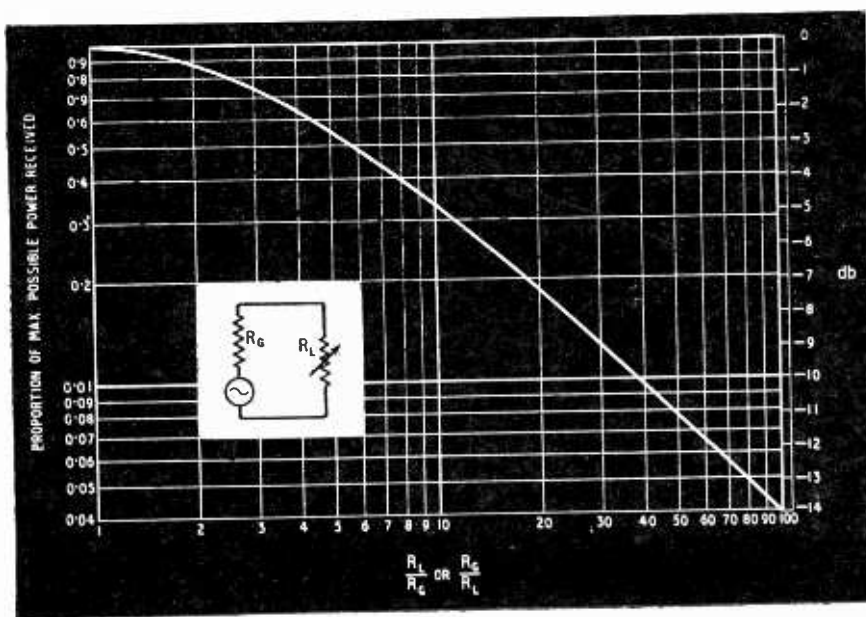

either way it should be so contrived that at all settings neither valve nor speaker will notice any difference. They ought both to be connected to the same resistances as before.

The same principle applies to line communications, only more so. All sorts of apparatus—amplifiers, attenuators, filters, etc.—may have to be connected one into the other, and to make this a reasonable proposition it is necessary to have a standard impedance so that they will all match one another; 600Ω is the most-used. The whole system is a chain of units, each having the same input and output impedance. If you are remembering that there is a 50% power loss in transfer between two perfectly matched units, you may at first think that each unit must lose that much of what is put into it, so that a system made up of many units must at the best be extremely inefficient. But it must be realized that the input impedance of any unit is reckoned with its output terminals connected to a matched impedance. Similarly, output impedance is reckoned only when the input is connected. Fig. 4(a) shows three connected units, all matched. Call their common impedance R . Then although the middle unit looks to both the others like a resistance R , this does not necessarily mean that the middle unit itself has any resistance or absorbs any power. For all they know it may contain nothing more than a pair of straight-through connecting wires, as at (b): Here the end units are represented by their resistances. If the source is disconnected and an ohmmeter substituted, it shows the input resistance is R ohms; and it is the same with the output resistance. With such internal connections, the middle unit might be an attenuator set to give zero attenuation. Whatever resistors an attenuator may contain, none of them must be in circuit—either series or shunt—at the zero setting.

Next, suppose we want to switch in some attenuation, to reduce the power in the load. Either series or shunt resistance would give us any amount of attenuation we wanted, but the system would no longer be matched. Series resistance would increase both input and output resistance of the attenuator; shunt resistance would reduce them. So a combination of both is needed. Now if you try putting one resistor in series and another in shunt you will see that however they are arranged the combination is lopsided. If the shunt is across the input terminals, then the input impedance is less than the output impedance; and vice versa. Clearly at least three resistors are needed for the attenuator to look like a resistance R from both ends. The two simplest arrangements are the T and the π , as in Fig. 5. One can see straight away that for equal input and output resistances they must be symmetrical; the two series resistors in the T must be equal, and so must the two shunt resistors in the π . The actual values of the resistors to give any desired attenuation can be calculated by simple formulæ, or looked up in tables. They are available in all the reference books on communication engineering, and there is an attenuator abac in *Radio Data Charts*. The formulæ for the two types in Fig. 5 are given at the end of this article. It is quite easy to see what the resistances should be for infinite attenuation; i.e., no power to reach the load. The shunt resistance of the T would have to be zero, and to keep input and output resistances right the series arms would each have to be equal to R . In the π , the series arm would have to be infinity—an open circuit—and the shunt arms each equal to R .

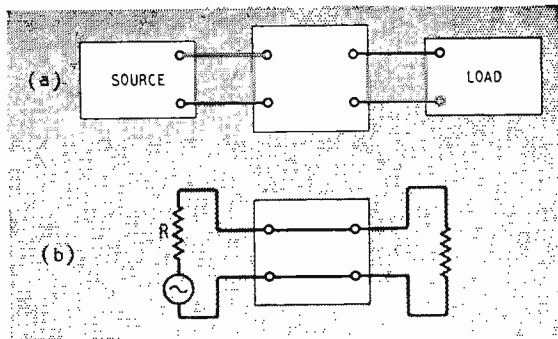

Fig. 4. Diagram (a) represents a unit matched at both ends to a source and load, having input and output resistances $=R$. At (b) the source and load are shown as they appear to the unit, which in this case has no resistance in itself, but because of its terminations it appears to both source and load as a resistance R .

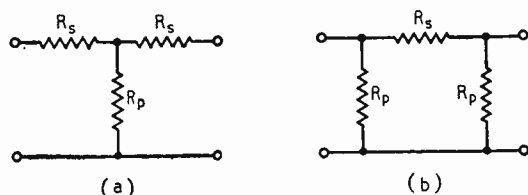

Fig. 5. The two simplest forms of attenuator capable of providing any amount of attenuation and at the same time matching equal input and output resistances

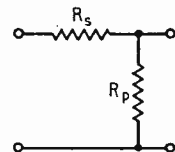

Fig. 6. This L type can provide any amount of attenuation and match any resistance at the end connected to R_s .

Sometimes it is good enough to keep the resistance right at one end only. For instance, it might be necessary for the generator to have a constant load, whereas the resistance across the load didn't much matter. In such cases one can make do with a two-arm attenuator, usually called the L type (Fig. 6). If you compare this with Fig. 1 you will see that in form it is exactly the same. But that doesn't mean that an ordinary "pot" will do. To keep the input resistance constant, the two arms have to be correctly proportioned, which means that their total resistance as the attenuation is varied cannot be constant.

Varying the Attenuation

This raises the question of how to do the variation in practice. One way is to make the attenuator arms ganged rheostats. It is rather complicated, because the shunt and series arms must have quite different "laws," and these call for rather tricky tapering of the resistance elements. But it can be done, if the range of attenuation to be provided is reasonable. For example, it would be unreasonable to expect the attenuation to be continuously variable down to zero, for that would necessitate a shunt resistance continuously variable up to infinity. Unless the attenuator were needed for precise measurements, however, a little mismatching would do no harm and one would

probably arrange for the shunt rheostat to open-circuit as it approached the zero-attenuation mark. For precise purposes, and also for greater ease of construction, attenuation is varied in steps by switching. There are all sorts of ways of doing it: in some (Fig. 7) each arm is controlled by one pole of a ganged tapping switch; in others (Fig. 8) complete attenuator units are switched in or out of circuit. Still another way—which fails to maintain exact matching at all settings, but is very cheap and convenient—is shown in Fig. 9; it is a favourite method for r.f. signal generators. There is a modification of the Fig. 7 type, called the Bridged-T, which reduces the number of switched sets of resistors from three to two; the two series arms in the T are both fixed at value R , and a single switched arm is added as a by-pass to them both.

In theory, a single stage is all that is needed to provide any attenuation, but in practice it is not a good idea to try to cover a very wide range with one stage. For one thing, stray capacitance would tend to by-pass the very high attenuation settings, especially at high frequencies. For another, some of the resistors would work out at awkwardly high or low values. This, by the way, is why sometimes a T is preferred to a π and other times the other way about. If a very wide range is needed, it is better to use several stages. The Fig. 8 system is ideal from this point of view, and is convenient for setting up a particular amount of attenuation required, but not where a lot of adjustment is to be done.

Attenuators as Transformers

So far we have been assuming the necessity, or at least the desirability, of having equal input and output resistances. In the one example we considered of a generator feeding a load of a different impedance—the valve and loudspeaker—the step-down was done by a transformer, so that whether an attenuator were put in the primary or secondary side it would be working between equal impedances. It may not be realized by everyone that the attenuator itself can be designed to serve also as the transformer. If the Fig. 6 type were used, and the series resistor were made $5,000 \Omega$ (or about $1\frac{1}{2} \Omega$ less, to be precise!) and the shunt resistor were made $2\frac{1}{2} \Omega$ (or a shade over), the valve would see a load of $5,000 \Omega$ and the loudspeaker

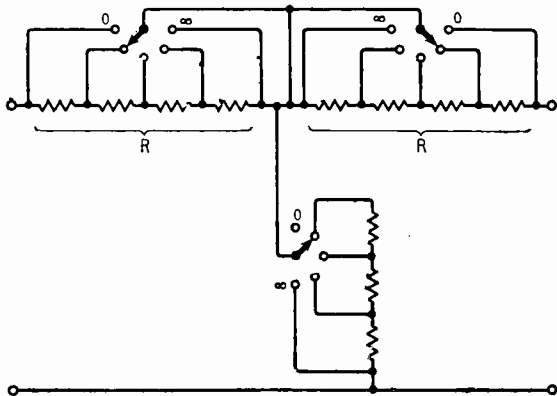

Fig. 7. The tapped-resistor method of controlling the attenuation of the T type unit.

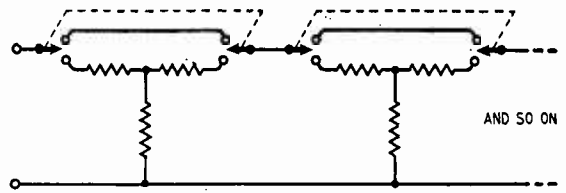

Fig. 8. In this method of controlling attenuation, fixed T units are switched in or out.

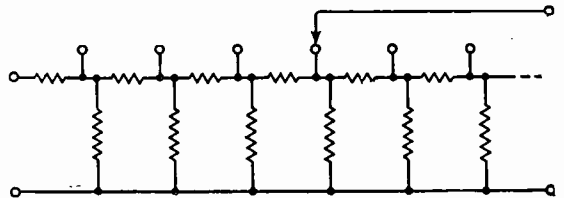

Fig. 9. This tapped ladder attenuator is much easier to make than Figs. 7 or 8, but does not give perfect matching.

would see a source of $2\frac{1}{2} \Omega$, so as regards impedance-matching nobody could find fault with the arrangement, and it would certainly cost much less than a transformer. There would of course be the trifling practical objection that the h.t. supply to the valve would encounter a resistance of $5,000 \Omega$ in place of the customary transformer winding; even if one were prepared to put up with that there might be some dissatisfaction owing to the *minimum* available attenuation being 39 db! The fact that one could arrange to vary it as much as desired beyond this figure would probably be small compensation for such an initial loss.

But that was rather an absurdly extreme example. With smaller resistance ratios the minimum loss is less: for matching a 2:1 ratio it is $7\frac{1}{2}$ db; for 3:1, 10 db; and so on. It is always decidedly greater than the loss resulting from direct connection (Fig. 3); the difference is the price paid for matching, which sometimes has important advantages apart from the question of power loss. The loss due to connecting the speaker direct to the valve, assuming that $5,000 \Omega$ was the internal resistance of the valve as well as its optimum load resistance, would be 33 db—6 db less than with the matching pad—but the distortion would almost certainly be much greater. So if one did come across a need for matching two unequal resistances and at the same time introducing some attenuation, the ability of a simple pad to do both at once might be worth knowing.

One result of the input and output impedances being dependent on what is connected at the other end is that if it is necessary to match a unit having an output at say 600Ω it is not enough to design the attenuator (or whatever is connected to it) to have an input of 600Ω . This can only be a kind of conditional promise that it will be 600Ω , subject to the co-operation of third or even fourth, etc., parties. It is like a firm's estimate bearing a footnote to the effect that it is subject to market fluctuations in the prices of materials and so on. In other words, the estimator is not wholly responsible for what he charges; he may have to pay a lot of what he gets from you to someone else, just as the attenuator has to pass on some of what it receives from the generator

to the load, the actual amount depending on the load's impedance. The extreme case is when the attenuation is zero, for then the input impedance of the attenuator is identical with the input impedance of the load. The greater the attenuation, the less what is connected at one end effects what is connected at the other. So in places where it can be arranged that there is always a fair amount of attenuation, it can also be ensured that one end is always quite well matched even though the impedance at the other end varies widely. Of course the departure from designed impedance causes an extra loss at that end; the amount can be found from Fig. 3.

An example of this sort of thing is the connection between a television aerial and the receiver. If the feeder is long, or exceptionally lossy, or has a matched attenuator between it and the receiver, then if the feeder itself is the right impedance for the aerial it makes little difference to the matching at the aerial end whether the receiver is a good match or not.

In case anyone wants to make an attenuator with equal input and output resistance (R) without having to look up the formulæ elsewhere, or having to work them out from first principles—which is a not very difficult exercise on Ohm's law—here they are for the T and π types. If N is the ratio of input to output voltage or current (square root of input to output power), then for the T type :

$$R_s = R \left(\frac{N - 1}{N + 1} \right)$$

$$R_p = R \left(\frac{2N}{N^2 - 1} \right)$$

The π type is the dual of the T type (for what this means see April 1952 issue) so the formulæ are the same except for conductance taking the place of resistance and series taking the place of parallel. The resistances are therefore :

$$R_s = R \left(\frac{N^2 - 1}{2N} \right)$$

$$R_p = R \left(\frac{N + 1}{N - 1} \right)$$

As an example, suppose the required attenuation is 10 db, which is a 10 : 1 power reduction, so $N = \sqrt{10} = 3.16$. Then for the T type $R_s = 0.52 R$ and $R_p = 0.70R$, and for the π type $R_s = 1.42R$ and $R_p = 1.92R$. Usually the T type is preferred, because it requires lower resistances.

Last Month's Problem

While we are busy with examples, here is the answer to last month's. You remember there was a parallel tuned circuit with resistance in each branch, and the problem was to find the frequency of resonance, this being defined as the frequency at which current would be in phase with applied voltage. In other words, the reactance of the circuit as a whole is zero. This circuit is covered by the formidable-looking equation that was given, but there is no need to cope with the whole of this ; all we have to do is to find the condition that makes the part controlled by j disappear—for that is the reactance part. So we write

$$X_1 X_2 (X_1 + X_2) + R_1^2 X_2 + R_2^2 X_1 = 0$$

In this particular case $X_1 = \omega L$ and $X_2 = -1/\omega C$,

ω being as usual the shorthand for $2\pi f$. So we have

$$-\frac{L}{C} \left(\omega L - \frac{1}{\omega C} \right) - \frac{R_1^2}{\omega C} + R_2^2 \omega L = 0$$

Multiplying both sides by ω ,

$$-\frac{\omega^2 L^2}{C} + \frac{L}{C^2} - \frac{R_1^2}{C} + R_2^2 \omega^2 L = 0$$

$$\omega^2 \left(R_2^2 L - \frac{L^2}{C} \right) = \frac{R_1^2}{C} - \frac{L}{C^2}$$

$$\omega^2 = \left(\frac{R_1^2}{C} - \frac{L}{C^2} \right) / \left(R_2^2 L - \frac{L^2}{C} \right)$$

$$f = \frac{1}{2\pi \sqrt{LC}} \cdot \sqrt{\frac{L - R_1^2 C}{L - R_2^2 C}}$$

The first term is the well-known expression for the resonant frequency of a series tuned circuit, or for a parallel circuit neglecting resistance ; the second is a correction factor which has no effect if R_1 and R_2 are either zero or equal to one another. Usually R_2 can be neglected but not R_1 , in which case the thing reduces to

$$\omega^2 = \frac{1}{LC} - \frac{R_1^2}{L^2}$$

which we came across in the January 1953 issue, on resonance curves.

RADAR ON ICE

Detection of Bergs and "Growlers"

THE value, and, too, the limitations, of radar as an aid to navigation in ice-infested waters were recently confirmed as a result of a 5,000-mile voyage in the Belle Isle and Hudson Straits by the ice breaker *N.B. McLean* fitted with Type 268 Naval radar equipment.

Investigations have previously been undertaken, but these were inconclusive in that the published reports did not give measurements of the actual radar response of ice targets. In order to obtain fuller information three investigators—two from the Ministry of Transport and one from the National Research Council of Canada—sailed in the ice breaker for two months last summer.

In the paper "Radar and Ice," recently presented to members of the Institute of Navigation, L. S. Le Page, who is in charge of the Radar Operational Research Group (M.o.T.), and A. L. P. Milwright, a senior experimental officer at the Admiralty Signal and Radar Establishment, summarized the findings. They stated that in calm weather, which is usual in fog, ice formations of all types can be detected—from large bergs at 20 miles, down to small "growlers" at $1\frac{1}{2}$ miles. The latter, which are smoothly rounded pieces of ice protruding up to 10ft out of the sea and weighing several hundred tons, however, are unlikely to be detected at ranges exceeding three miles. The authors emphasize that for a ship travelling at 15 knots this represents a warning period of only 12 minutes, and it is obvious, therefore, that a continuous radar watch must be kept

when navigating in waters where ice is to be expected. With rough seas and bad visibility, when sea clutter on the p.p.i. may extend beyond one mile, it is unsafe to rely upon radar navigation, as growlers may not be detected.

Fields of tight pack-ice composed of hummock ice can, it is stated, be detected under all sea conditions up to ranges of approximately three miles, as can "leads" through the ice of over 200 yards width.

A great deal of summer ice of all types was observed

during the voyage, from soft pack-ice to bergs up to 200ft high. These were recorded photographically and detailed radar measurements were carried out on some 60 ice formations. The results of these investigations (which, incidentally, provided no proof that atmospheric conditions reduce detection ranges), and recommendations for improving the performance of marine radar gear for ice detection are given in the paper which will be published in full in the *Journal of the Institute of Navigation*.

Time by Telearchies

Experimental Radio-Controlled Clock

CONSIDERING the number of years people have been in the habit of setting their clocks by radio time signals, one would have thought some system could have been devised for using such signals for the automatic control of clocks. It seems such a simple and obvious step to take. Actually a good many experimenters have toyed with the idea, but have had to give it up—probably through the lack of a sufficiently regular and reliable service of signals.

This year, however, the idea may become rather more of a practical proposition, for we understand that the National Physical Laboratory is hoping to broadcast from Rugby a regular 24-hour service of standard frequencies, including pulses of 1-kc/s tone at one-second intervals. This will be an extension of the present restricted service from Rugby (see note on page 119). The pulses will be radiated for a period of 5 minutes in each 15-minute transmission cycle, as at present, throughout the day. They will be gener-

ated locally at Rugby but will be monitored by the Royal Observatory station at Abinger and periodically corrected so as to be as nearly as possible in step with astronomical time. The discrepancy may amount to about 50 milliseconds at the worst. Thus, although the pulses are really intended as a standard frequency, they will, in fact, provide a very accurate time service.

To make use of this proposed new service, an experimental radio-controlled clock has already been built by S. J. Smith* and J. K. Langham*, and was demonstrated recently to the British Horological Institute. It is a conventional pendulum clock in which the pendulum is kept in step with the pulses by means of an electromagnetically-operated pawl. This pawl strikes a vertical piece of spring steel on the pendulum and bends it either one way or the other, depending on whether the pendulum is in advance or retard. The energy stored in the bent spring then serves to accelerate or slow down the pendulum so that the error is corrected.

On the electronic side the main problem is that the pulses from the receiver are of too short a duration (5 milliseconds) to operate the electromagnet properly as they stand. It has therefore been necessary to "stretch" them to 80 milliseconds by means of a storage capacitor. As a result of this operation they lose some of their sharpness, so they have to be put through a squaring device (a flip-flop circuit) to make them sufficiently sharp to give the necessary rapid operation of the electromagnet. Actually, only the first and last pulses of the 5-minute period are used. The remainder are cut out by a time switch operated by the clock, which also serves to eliminate the rest of the 15-minute transmission cycle.

The clock has been tried out on an experimental transmission on $2\frac{1}{2}$ Mc/s, and it is claimed to behave very well in areas of reasonable signal strength. Unfortunately, however, the transmitter does not give complete coverage of the British Isles (in London the signal is particularly bad), and this rather limits the application of the system.

The pendulum clock is on the left and the electronic apparatus is in the unit on the right. The pendulum of the clock maintains a good time standard of its own accord and will thus cover short breakdowns in transmission.

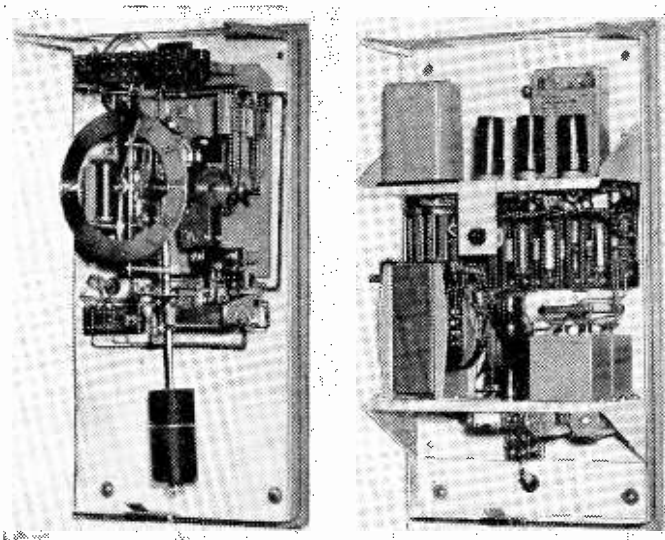

* Telephone Manufacturing Company.

Television for Italy

The largest foreign order for television equipment placed in Britain has been awarded to Marconi's Wireless Telegraph Co. Ltd., by the Italian State Broadcasting Corporation.

The order includes large complete studio centres at Milan and Rome, O.B. units for Rome, and medium power transmitting stations at Rome and Pisa. The service will operate on CCIR international standards of 625 lines, 50 fields.

This order follows those for television installations in the U.S.A., South America, Canada and Thailand.

Marconi high-power or medium-power transmitters and high-power aerials are installed in every one of the B.B.C.'s Television Transmitter Stations.

MARCONI

complete television transmitting equipment

MEET THE ROYAL FAMILY — — — — — VIA LARGE SCREEN PROJECTION TELEVISION

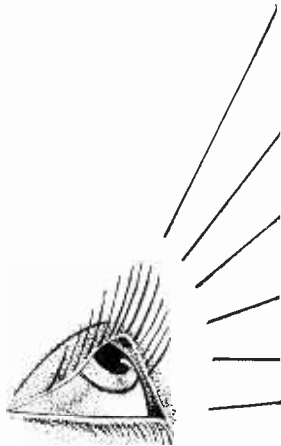

YOU WILL SEE MORE OF THE CORONATION ON TELEVISION THAN IF YOU HAD A FRONT SEAT — — — — — AND YOU WILL SEE MORE DETAIL AND REALISM ON THE SS PROJECTION TELEVISOR THAN YOU THOUGHT POSSIBLE.

**SO
OBVIOUSLY
BETTER
£145**

SOUND SALES LTD
WEST STREET, FARNHAM, SURREY
Telephone : Farnham 6461-2-3

WEBB'S RADIO
14 Soho Street, Oxford Street, W.1
Telephone : GERrard 2089

HOLLEY'S RADIO STORES
285 Camberwell Rd., London, S.E.5
Telephone : RODney 4988

NEW!

E·M·I INSTITUTES **EXPERIMENTAL KIT**

LEARN THE PRACTICAL WAY

A specially prepared set of radio parts from which we teach you, in your own home, the working of fundamental electronic circuits and bring you easily to the point when you can construct and service a radio set. Whether you are a student for an examination, starting a new hobby, intent upon a career in industry, or running your own business — this Course is intended for YOU — and may be yours at a very moderate cost. Available on Easy Terms

WE TEACH YOU : *Basic Electronic Circuits (Amplifiers, Oscillators, Power Units, etc.) Complete Radio Receiver Testing & Servicing.*

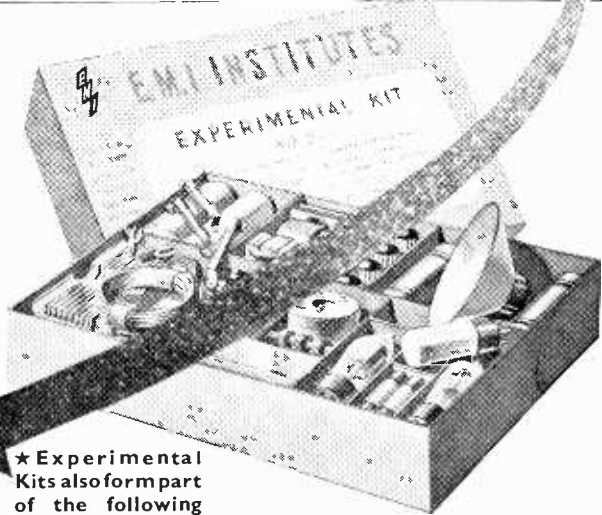

POST IMMEDIATELY FOR FREE DETAILS

TO: E.M.I. INSTITUTES, DEPT. 16K
Grove Park Road, Chiswick, London, W.4

Name

Address

..... I.C.12

★ Experimental Kits also form part of the following courses: Draughtsmanship, Carpentry, Chemistry, Photography, Commercial Art, etc.

EMI INSTITUTES
Associated with
MARCONIPHONE
COLUMBIA & HMV
(His Master's Voice)

Flywheel Synchronization

Avoiding Line Jitter in Television Fringe Areas

By B. T. GILLING

THE noise content of the vision signal in fringe areas degrades the picture in two ways. First, it superimposes a grain on the actual picture, and secondly it mutilates the line sync pulses, causing the line time-base to fire in a random manner around the pulse and not at its leading edge. This second effect is by far the more serious as the irregular displacement of lines causes what is in effect serious horizontal defocusing. Any method of locking the time base directly from the sync pulses will suffer from this defect.

A way of overcoming this trouble is the utilization of flywheel synchronizing, or, as it is known in America, automatic frequency control. In this system, the frequencies of the sawtooth output from the line time-base and of the incoming sync pulses are compared in a discriminator circuit. A resultant output voltage is obtained whose polarity and amplitude are dependent on the frequency difference of the two input frequencies. This voltage is passed through a fairly long time-constant RC filter to average out the irregularities and then used to control the frequency of the sawtooth generator. Thus, the line time-base is no longer controlled by each individual line sync pulse but by the average of a large number.

The most noticeable improvement seen when flywheel sync is used is on the verticals. The three sketches in Fig. 1 illustrate this; (a) is an ideal vertical line, and (b) and (c) the same line as seen in fringe areas with considerable noise present. The first is with normal direct synchronizing and the second using flywheel sync. The difference between the two latter

lines is self-evident. With direct synchronizing the line is broadened and blurred, whereas with flywheel sync, although at times of very severe noise the line may be slightly curved and waving, it is definite, clear and of the correct width.

There are several methods of flywheel synchronizing, some of which are fairly complex and require specially designed transformers, but the system to be described in this article is simple and calls for the use of no specialized components. It is so easily applied to existing sets and so simple to get to work that, when one considers the enormous improvement in picture quality obtained with it, it is a matter of real surprise that it is almost never used in this country in sets designed for fringe area reception.

The basic circuit of the frequency discriminator is shown in Fig. 2. Negative-going sync pulses from the normal sync separator are fed to the grid of V_1 and appear at its anode and cathode in opposite phase. The positive pulse at the anode makes the diode $V_2(a)$ conduct to earth through R_3 , and similarly the negative pulse at the cathode causes $V_2(b)$ to conduct to earth also through R_3 . The pulses pass the outer ends of the joined resistors R_3, R_4 at the same instant and, since these pulses are equal and opposite, there will be no potential difference between point "A" and earth. A small portion of the sawtooth from the anode of the line output valve is applied to the joined anode and cathode of the two diodes. As the diodes conduct only at the time of the sync pulses, this is the only time that the sawtooth will be able to affect the circuit, and this occurs only during the flyback period.

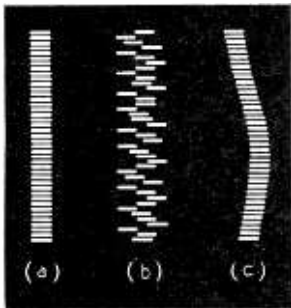

Fig. 1. Appearance of a vertical line on the screen: (a) ideal vertical line, (b) with normal synchronization in fringe areas (c) with flywheel sync.

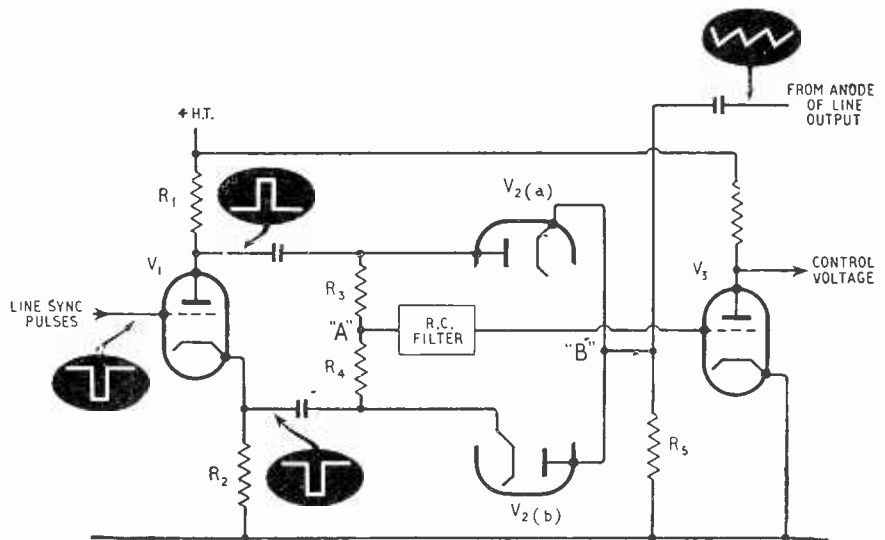

Fig. 2. Basic circuit of frequency discriminator.

This will give rise to three situations which must be examined in detail.

Before dealing with these three states we must examine the relationships between the incoming sync pulses and the sawtooth. The sawtooth applied to the grid of the line output valve has its flyback going from positive to negative, therefore at the anode the flyback goes from negative to positive. When this sawtooth reaches point "B" in Fig. 2 it has lost its peaks and is of the shape shown in Fig. 3(b). Fig. 3 shows graphically the three conditions met with, all drawn on the same horizontal time scale, (a) representing the sync pulses as they reach "B." In 3(b) the sawtooth is of the exact frequency of the pulses. In 3(c) the time base is running too fast and the flyback has passed its zero position and reached a positive potential at the time of the arrival of the pulse. In 3(d) the opposite is the case. The time base is slow and the flyback is still negative when the pulse arrives.

The effect these three conditions have on the discriminator must now be examined. The first condition is when the flyback is passing through its zero

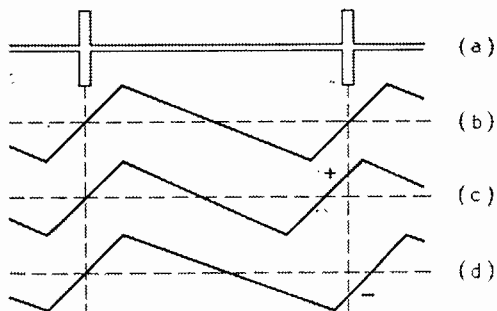
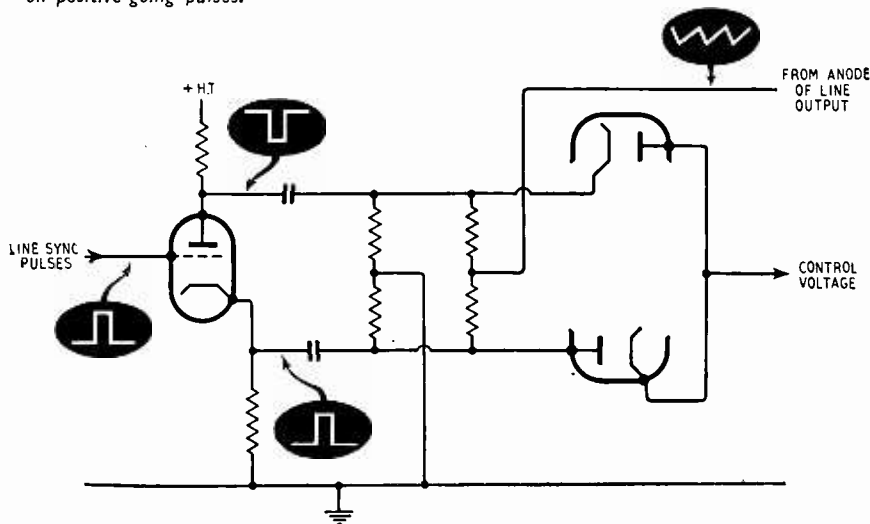

Fig. 3. Relationships between incoming sync pulses and sawtooth at anode of line output pentode.

Fig. 4. Alternative arrangement of discriminator, to work on positive-going pulses.



position at the moment of arrival of the pulse (b). This will cause no disturbance at point "B" and the zero potential difference between "A" and earth will remain unchanged. This is the ideal state of affairs, the incoming pulses and the sawtooth being in synchrony.

The second state is when the time base is running slightly too fast and therefore the flyback is positive at the moment of arrival of the pulse [Fig. 3(c)]. The positive flyback potential appears equally at the cathode of $V_{2(a)}$ and the anode of $V_{2(b)}$, causing $V_{2(a)}$ to conduct the positive pulse from the anode of V_1 less well and $V_{2(b)}$ to conduct the negative pulse from the cathode better. Thus the anode of $V_{2(a)}$ becomes more positive and the cathode of $V_{2(b)}$ less negative and point "A" becomes positive relative to earth. After being passed through a fairly long time-constant RC filter the positive voltage from "A" is applied to the grid of V_3 , a d.c. amplifier, causing its anode current to increase and the voltage at its anode to move negative. If this anode is connected in some way to the control point of the sawtooth generator the change to a more negative voltage will reduce the generator's frequency, pulling it into step with the incoming sync pulses.

The third state is when the sawtooth is slower than the sync pulses [Fig. 3(d)]. In this case the pulse will arrive at "B" when the flyback is negative and circuit conditions will be the reverse of the second state. $V_{2(a)}$ will conduct more, $V_{2(b)}$ less, and a potential negative to earth will appear at "A." This, when applied to the grid of V_3 , will make the anode go more positive and the frequency of the generator will be increased.

There are many variations of this basic discriminator circuit. One of these is shown in Fig. 4 arranged to work on a positive-going sync pulse. Its operation is essentially the same as Fig. 2.

A detailed circuit for practical application is shown in Fig. 5. It is very easy to get going and after the theoretical considerations above few operational notes are necessary. The pairs of resistors R_{3-5} and R_{6-7} , must be either matched or of close tolerance. Special attention must be given to the 680-k Ω resistor R_{10} . This is connected to the anode of the line output pentode where very high peak voltages appear.

A single resistor is not advisable: the value should be made up of two one-watt resistors connected in series and so placed that their insulation to earth is high. It may well be found that the discriminator will work with a higher value of R_{10} , depending on the type of line output stage used. The highest value consistent with satisfactory operation should be used. A resistor of up to 2,000 Ω in the cathode lead of $V_{1(b)}$ will sometimes improve operation but should not be needed. With regard to valves, any double diode with separate cathodes can be used and a 6SN7 is quite satisfactory for the triodes.

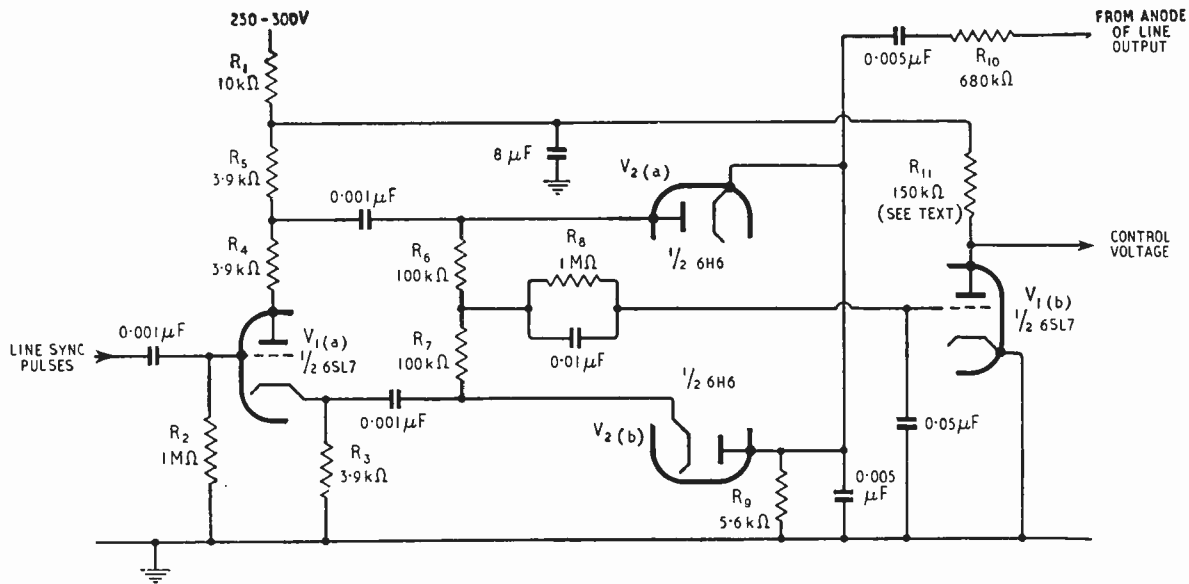
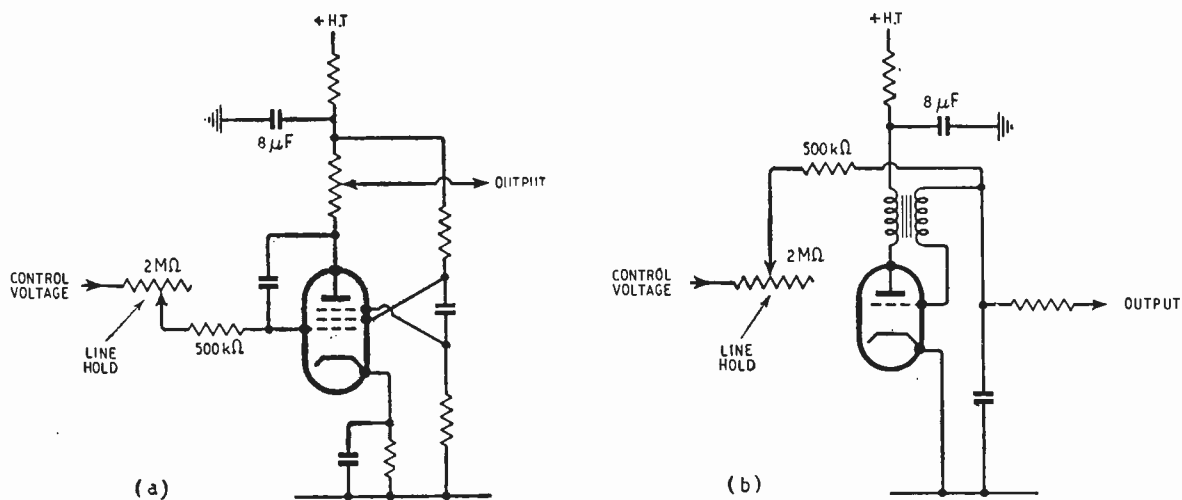

Fig. 5. Complete circuit diagram of frequency discriminator and d.c. amplifier for negative-going sync pulses.

Fig. 6. (a) Control applied to transiron sawtooth generator as in the Wireless World television receiver. (b) Control applied to a blocking oscillator sawtooth generator.



Line time-bases are almost always either transistors, blocking oscillators or multivibrators, and line hold is usually controlled either by a variable high resistor taken to +h.t. or by a potentiometer across the h.t. supply. To control the time-base by the discriminator output voltage the two methods are combined. The high-value variable resistor is used as a manual hold control and, instead of being taken to +h.t., it is connected to the anode of the d.c. amplifier. This valve and its load resistor (Fig. 5 $V_{1(b)}$, R_{11}) form a potentiometer across the h.t. supply and since the voltage at the anode is controlled by the discriminator the frequency of the time-base will be pulled into step with the sync pulses. The actual value of R_{11} must be found experimentally. When the circuit is being put into operation a variable

resistor of about 500kΩ must be substituted. With the manual line-hold control at about its mid position, adjust the variable resistor until the picture locks. The variable resistor is then measured and the same value wired into circuit. The minimum value of this resistor is about 50kΩ. Anything lower will reduce the efficiency of the control.

Two representative time-base circuits are given in Fig. 6. The first is a transiron as used in the *Wireless World* receiver and the second a blocking oscillator. The control is indicated in each. The setting of the line hold moves the picture slightly across the screen. In the writer's set the total movement is about half an inch on a twelve-inch screen. It is important that this control be set so that the picture is correctly centred, otherwise there is a

tendency for the picture to be slightly distorted at the top.

A receiver based on the *Wireless World* design was modified to incorporate the above system of flywheel synchronizing shortly after the Wenvoe transmitter opened on low power. The set is situated about one hundred miles from the station and the improvement in picture quality was remarkable. Even on a weak signal, lettering on the screen could be read with ease, whereas before it was impossible to make out individual words. Since Wenvoe has increased to full power, comparison with other sets in the neighbourhood makes the worthwhile-nature of flywheel sync very evident. In fact, in the writer's opinion, any set, in however good a signal area, which shows any raggedness of verticals will benefit greatly by its use.

A very complete account of the many methods of automatic frequency control appeared in a series of articles in the American magazine *Radio & Television News* for the months of January, February and March, 1950, and the present writer acknowledges his indebtedness to these.

Short-wave Conditions

Predictions for March

THE full-line curves given here indicate the highest frequencies likely to be usable at any time of the day or night for reliable communications over four long-distance paths from this country during March.

Broken-line curves give the highest frequencies that will sustain a partial service throughout the same period.

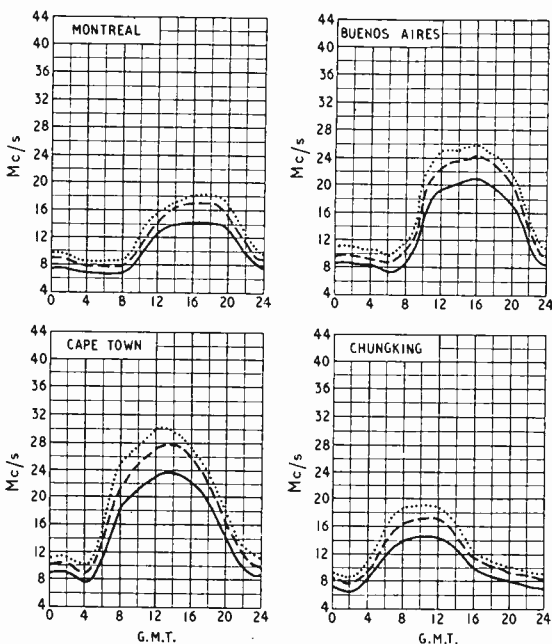

— FREQUENCY BELOW WHICH COMMUNICATION SHOULD BE POSSIBLE ON ALL UNDISTURBED DAYS
 - - - PREDICTED AVERAGE MAXIMUM USABLE FREQUENCY
 FREQUENCY BELOW WHICH COMMUNICATION SHOULD BE POSSIBLE FOR 25% OF THE TOTAL TIME

BOOKS RECEIVED

Electrical Units (with special reference to the M.K.S. system) by E. Bradshaw, M.Sc.Tech., Ph.D., M.I.E.E. Comparative assessment of the characteristics of systems of electrical units, with tables of conversion factors. Pp. 64; Figs. 9. Chapman & Hall, 37, Essex Street, London, W.C.2. Price 9s 6d.

World Radio Handbook for Listeners (Seventh edition). Edited by Lund Johansen. Data on the principal broadcasting stations of the world, including interval signals and times of transmission. Pp. 124 with many illustrations. *World Radio Handbook*, Lindorffsalle 1, Hellerup, Denmark. Price 8.50 Danish Kr., \$1.50 or 8s 6d (postage extra). Supplies in Gt. Britain may be obtained from Wm. Dawson and Sons, Ltd., Cannon House, Macklin Street, London, W.C.2, by post at 9s.

La Pratique des Magnétophones by P. Hemardinquer. Construction, adjustment, fault-finding, maintenance and applications of magnetic recording equipment. Pp. 180; Figs. 95. Editions Chiron, 40, Rue de Seine, Paris 6. Price 870fr.

Leitfaden der Funkortung (Guide to Radio Location) by W. Stanner (and co-workers). Comprehensive survey of direction finding, radar, hyperbolic chain systems, etc., including a chapter on radio astronomy. Pp. 163; Figs. 85. Electron-Verlag, Maxstadtstrasse, 1, Garmisch-Partenkirchen, Germany. Price 12 DM.

Temperature and Humidity Gradients in the First 100m Over South-East England, by A. C. Best, M.Sc., E. Knighting, B.Sc., R. H. Pedlow, B.Sc., and K. Stormonth, B.Sc. Analysis of data, of importance in the propagation of radio and radar signals, collected over a period of three years, giving the mean variation of temperature and humidity at different heights, and of the lapse rate of these quantities for each month. Maximum values, and the frequency of occurrence of other magnitudes of the lapse rates of temperature and humidity are included. Pp. 60, Figs. 18. H.M. Stationery Office, York House, Kingsway, London, W.C.2. Price 7s 6d.

Measurements at Centimeter Wavelength by Donald D. King. Survey of theoretical principles and practical methods of measurement, including chapters on generators, detectors, the measurement of impedance and of radiation. Pp. 327+vii; Figs. 219. D. van Nostrand Company and Macmillan and Co., Ltd., St. Martin's Street, London, W.C.2. Price 42s.

Radio and Radar Technique by A. T. Starr, M.A., Ph.D., M.I.E.E. Written for readers, with basic knowledge of university degree standard, who require in one volume a comprehensive digest of the post-war literature on communication and radar techniques. Special emphasis is given to the role of noise in electronic systems, fundamental behaviour of special valves, microwave techniques and pulse waveforms. Pp. 812+xvii; Figs. 488. Sir Isaac Pitman & Sons, Ltd., Parker Street, London, W.C.2. Price 75s.

Radio Upkeep and Repairs by Alfred T. Witts, A.M.I.E.E. Revised seventh edition of this handbook on servicing principles and receiver maintenance. Pp. 220+iv; Figs. 159. Sir Isaac Pitman & Sons, Ltd., Parker Street, London, W.C.2. Price 12s 6d.

Home Mechanic's TV Servicing by William R. Wellman and Joseph J. Kadrl. Written from the point of view of American requirements and contains many hints and tips of general utility. Pp. 159+viii; Figs. 66. D. van Nostrand Company and Macmillan and Co., Ltd., St. Martin's Street, London, W.C.2. Price 21s.

Electricity in the Home by C. B. Brook, A.M.I.E.E. Primarily written for domestic appliance users and car owners, with advice on maintenance and elementary fault-finding and repairs. Pp. 204; Figs. 86. Advertiser Press, Ltd., Page Street, Huddersfield. Price 6s 6d.

EDISWAN

CLIX

Offer the widest range of type-approved valve-holders

which includes:—

B7G, B8G, B9A and B9G

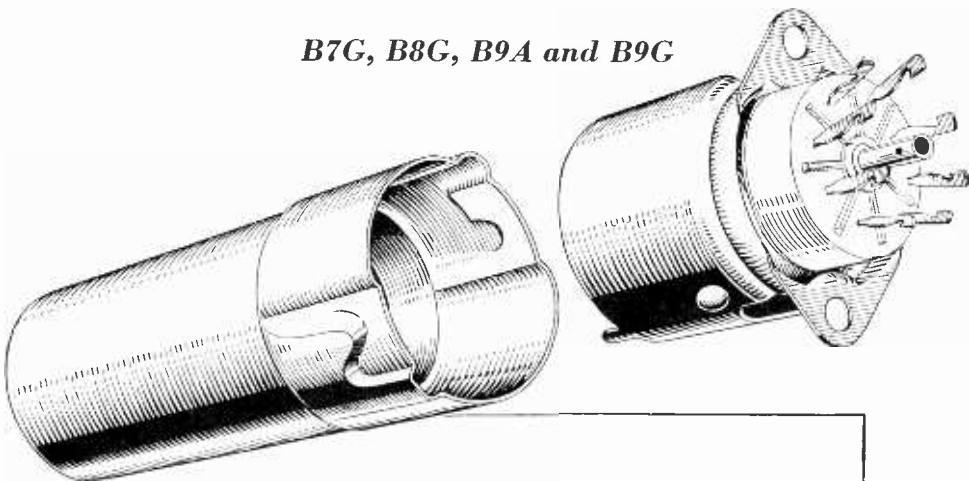

All fully type-approved to R.C.S. 251 Grades 1 & 2. Categories 1 & 2. Together with a complete range of screening-cans & top-cap connectors.

Comprehensive catalogue of EDISWAN CLIX radio components available from

THE EDISON SWAN ELECTRIC COMPANY LIMITED
155 Charing Cross Road, London, W.C.2. Sales Dept: 21 Bruton Street, W.1

ER14

Member of the A.E.I. Group of Companies

FREE

THIS VALUABLE BOOK

which details the wide range of Engineering and Commercial courses of modern training offered by E.M.I. Institutes — *the only Postal College which is part of a world-wide Industrial Organisation.*

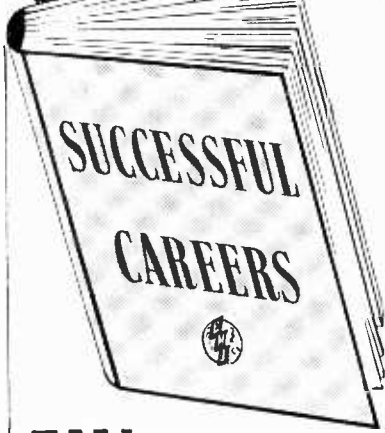

Courses include training for :

City and Guilds Grouped Certificates in Telecommunications ; A.M. Brit. I.R.E. Examination, Radio Amateur's Licence, Radio & Television Servicing Certificates, General Radio and Television Courses, Radar, Sound Recording, etc. Also Courses in all other branches of Engineering.

EMI INSTITUTES
associated with

**MARCONIPHONE
COLUMBIA &
H.M.V.**
(His Master's Voice, etc.)

COURSES
FROM
£1
PER MONTH

POST NOW

Please send, without obligation, the above FREE book
E.M.I. Institutes, Dept. 16,
43 Grove Park Road, Chiswick, London, W.4.

Name

Address

IC10E

TRUVOX

It **Pays As You Earn!**
EQUIPMENT

Profitable P.A. business is built upon a reputation for reliability which can only be based on the dependability of your equipment. That is why it pays to use only TRUVOX, the reproducers that have had reliability built into them for a quarter of a century.



TRUVOX REFLEX SPEAKERS

Senior models give a substantially linear response from 250 to 8,000 c.p.s. with a peak handling capacity of 8 to 10 watts whilst Junior models range from 350 to 8,000 c.p.s. with 6 to 8 watts peak handling capacity. Either can be supplied with built-in transformer. Completely weather-proofed and designed to withstand prolonged exposure and vibration.



TRUVOX PRESSURE TYPE DRIVING UNITS

Senior and Junior models have a power handling capacity of 15 and 10 watts respectively and provide a substantially linear response from 175 to 10,000 c.p.s. The Senior model is available with built-in tropicalised multi-ratio transformer, a noteworthy feature much appreciated by sound engineers.

For Full Details Write to :

ROLA CELESTION LTD., FERRY WORKS, SUMMER ROAD, THAMES DITTON, SURREY

Phone: Emberbrook 3402-6.

Wholesale enquiries to—Truvox Ltd., Exhibition Grounds, Wembley, Middx. (WEM 1212)

Calibrating V.H.F. Oscillators

Method Requiring Only Two Known Frequencies in Each Range

By M. C. MATTHEWS

THE writer recently constructed a grid-dip oscillator covering the band 40–60 Mc/s for use in testing and adjusting television sets and, having completed it, was faced with the problem of calibration. The usual method of beating the oscillator against a standard signal generator was not possible as no such instrument was available. Various possibilities were considered, and eventually examination of the tuning capacitor suggested the procedure which follows.

The success of the method depends on the fact that the usual pattern of high frequency tuning capacitor of the order of 50 pF maximum capacitance having semi-circular plates has, once the fixed and moving plates are partly meshed, a linear relationship between rotation and capacitance. This being the case it is only necessary to determine accurately two points on the scale in order to be able to calculate the remainder.

The method is perhaps best explained by describing the procedure used in the case of the writer's instrument. This is fitted with a drive scaled 0–180 and arranged so that scale reading increases with capacitance.

It is first necessary to determine the two reference points, and this was done by beating the oscillator first against the sound carrier on 41.5 Mc/s and then, with a pair of phones on the detector, against the vision carrier on 45 Mc/s. In this particular case it was required that the sound frequency should fall near one end of the scale, so the inductance of the coil was adjusted until it fell at 155, at which point the capacitor vanes were adequately meshed. The vision carrier then fell at 112.

The mathematics of the formula used are simple and are adequately covered in the Appendix, and it is only necessary here to say that we now proceed to substitute

How a calibration curve is obtained from two known points only. These are the encircled ones while a calculated point is shown in a square.

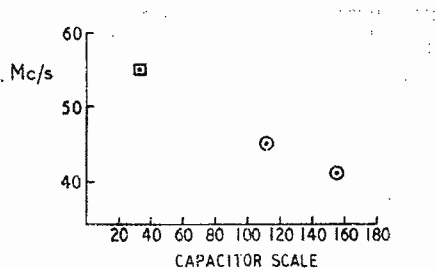

in the equation $D + C_1 = \frac{K}{f^2}$, where D = dial reading, C_1 = a constant proportional to the minimum and stray capacitances, K = a constant and f = the operating frequency in Mc/s.

The first step is to determine the two constants K and C thus :—

Inserting the known values for the reference points we have

$$155 + C_1 = \frac{K}{1,722} \quad \dots \dots \dots (1)$$

$$112 + C_1 = \frac{K}{2,025} \quad \dots \dots \dots (2)$$

Subtracting (2) from (1) we get

$$155 - 112 = \frac{K}{1,722} - \frac{K}{2,025}$$

$$\therefore 43 = \frac{303K}{3,487,000}$$

$$\therefore K = 495,000$$

Substituting for K in (1) we get

$$155 + C_1 = \frac{495,000}{1,722}$$

$$\therefore C_1 = 132$$

Having determined C_1 and K the rest is simple arithmetic. It is best to set out a table as shown below.

It must be repeated that it is not safe to extend these calculations to within less than about 20 deg of the limits of travel of the moving plates. If the drive is arranged so that the reading varies inversely with capacitance it is only necessary to commence by subtracting the dial readings of the reference points from the full scale reading in order to obtain a figure which varies directly with capacitance. After the calculations are complete the figures in column 4 of

TABLE

1	2	3	4
f (Mc/s)	f^2	$\frac{K}{f^2}$	(3) - C_1
41.5	1,722	287	155
42.0	1,765	280	148
42.5	1,810	274	142
43.0	1,852	267	135
43.5	1,895	261	129
44.0	1,940	255	123
etc.			

the table must then be deducted from the full scale reading in order to obtain true dial readings.

The method has obvious limitations, but in suitable cases it provides a simple and accurate method of calibration.

APPENDIX

The procedure described above is based on the equation

$f = \frac{K_1}{\sqrt{LC}}$, where f = resonant frequency, K_1 = a constant, L = inductance in circuit and C = total capacitance in circuit.

In the present case L is a constant as well as K , and we can therefore rearrange the equation thus:—

$$C = \frac{K_1^2}{f^2 L}$$

$$= \frac{K_1}{f^2} \text{ where } K_2 = \frac{K_1^2}{L}$$

Now the dial reading D is proportional to the capacitance of the tuning capacitor if a constant C_1 is added, this constant being proportional to the minimum capacitance of the circuit. We therefore have

$$C = (D + C_1)K_3$$

Substituting this for C in the first equation we get

$$(D + C_1)K_3 = \frac{K_2}{f^2}$$

and therefore $D + C_1 = \frac{K}{f^2}$ where $K = \frac{K_2}{K_3}$.

TELEVISION SOCIETY'S EXHIBITION

THE Television Society's annual exhibition of equipment related to television design and production was held in London on January 23rd and 24th; there were 35 exhibitors. A feature of the exhibition was its dynamic character, for an unusually large number of the exhibits were demonstrations of an instructional nature.

E. K. Cole, for instance, showed two identical receivers working side by side, one having spot-wobble in operation and the other without it. Line broadening without spot-wobble was demonstrated by T. Kilvington of the Post Office Research Department, who showed a receiver in which the scanning spot is deformed to a short vertical line by two small pieces of magnetic material placed diametrically opposite one another in the gap of the focus magnet.

The shape and path of the electron beam in a c.r. tube were made visible by L. S. Allard of the G.E.C. Research Laboratories, who showed a special tube having a plate coated with fluorescent material and lying on the axis of the tube, its shape fitting the inside contours. The beam is given a small vertical deflection to avoid the need for accurate alignment, and this produces a vertical line on a narrow band of fluorescent material on the face of the tube. The whole path and shape of the beam can be seen from inside the deflector coils to the screen, and the effect of focusing and deflection upon the beam can be studied in detail.

Ediswan showed a tube having only part of its screen aluminized, operating with a raster to illustrate the effect of aluminizing, and another tube with a layer

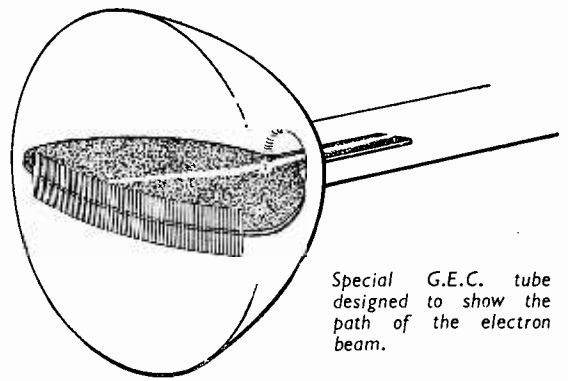

Special G.E.C. tube designed to show the path of the electron beam.

of liquid outside the screen to show how a suitable material can remove "halo."

The effect of flywheel synchronizing in reducing the effect of noise and interference upon line synchronizing was well brought out by the Ferguson exhibit. This comprised a receiver arranged to switch from one form of synchronizing to the other and operating with a local source of interference superimposed on the television signal.

Flywheel sync was also used in the apparatus shown in operation by Murphy Radio. This comprised a modified V204 receiver chassis operating a 24-in. c.r. tube working at 18 kV. Other large-screen directly viewed sets were shown, including the 17-in. Alba a.c./d.c. model in which the e.h.t. supply is 17.5 kV.

Projection models were also there in numbers and use the Mullard 2½-in. tube with 25 kV e.h.t. and the Schmidt optical system. The Ferranti set is unusual in having a push-pull video stage, while the Nera sets depart from convention in being of the front-projection type. The model C30 is an especially neat set in that it is self-contained, the screen hinging upwards and the projector pulling out from the front for use. The Decca set giving a 4-ft by 3-ft picture is also of the front-projection type.

Mullard showed a range of c.r. tubes, including the MW36-24, having rectangular screen of 14-in. diagonal and a grey face, while Cinema-Television showed a projection tube for producing the very large picture needed for the cinema. Oscilloscope tubes appeared in the display by 20th Century Electronics.

Test equipment formed a substantial section of the exhibition. One item was a television field-strength measuring set shown by Belling & Lee. The carrier of the sound signal is used to operate a meter to show the level of this signal and the video signal is displayed on a c.r. tube, the amplitude of the frame sync pulses being used as a measure of signal strength. By having this visual display the effect of "ghost" signals can be observed.

Philips Electrical utilized their Composite Pattern Generator to provide one source of signals for distribution around the exhibition, the other sources being the B.B.C. and a camera in the exhibition room. Telequipment showed a pattern generator and monoscope equipment for factory use, while Bush Radio displayed a generator producing 525- and 625-line signals with negative modulation and f.m. sound. This is for testing apparatus designed for the American and Continental standards. In addition to providing test patterns, it can accept live signals derived from the B.B.C. 45-Mc/s vision signal and the 90-Mc/s f.m. signal from Wrotham.

Manufacturers' Products

NEW EQUIPMENT AND ACCESSORIES FOR RADIO AND ELECTRONICS

Moulded Nylon

NYLON is best known as a textile material, but it is now beginning to figure in various branches of mechanical and electrical engineering as plastic mouldings of one kind or another. It is a thermo-setting plastic and may be re-heated and re-shaped many times without greatly affecting its physical properties.

Most thermo-setting plastics soften in the region of 180 deg F but nylon will remain hard up to 300 deg F, its melting temperature being about 480 deg F.

In view of its heat-resisting qualities it is interesting to speculate on its potential usefulness as a radio insulator. Its electrical insulation properties are good and comparable with many other moulded insulators and it has some definite advantages on the score of mechanical strength.

The dielectric constant of moulded nylon at 1 Mc/s is given as 3.4, its dielectric strength (short time) as 385 V/mil and the power factor as 0.04. Whilst its radio uses may, for the time being, be limited to the lower frequencies it nevertheless has many applications where high mechanical strength without undue bulk and weight and heat-resisting qualities have an overriding influence. Certain kinds of coil formers come to mind where soldering is required to integral tags and contacts without risk of the material softening.

British Ropes, Ltd., have for some time past specialized in the production of nylon mouldings in their Leith, Edinburgh, factory and they are prepared to investigate new applications for the material.

Miniature Signal Lamp

A LILLIPUTIAN signal lamp fitting moulded in a material which is both tough and moisture resisting forms the latest addition to the range of signal lamps made by A. F.

Bulgin miniature moulded signal lamp fitting Type D675 available in five different colours.

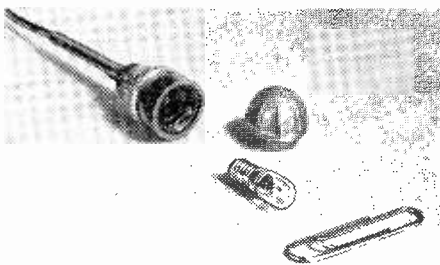

Bulgin and Co., Ltd., Bye-Pass Road, Barking, Essex. Some idea of its small size can be judged by the following dimensions: overall diameter just over $\frac{1}{2}$ in and overall depth, back to front, $1\frac{1}{4}$ in. It is single-hole fixing and needs a $\frac{3}{8}$ -in diameter hole. Provision is made for fitting to panels up to just under $\frac{3}{8}$ in thick.

The fitting is in two parts, a black moulded body containing the miniature screw-type lamp holder, which incidentally measures only $\frac{3}{16}$ in in diameter, and a screw-in domed-shaped lens made of a translucent material and available in red, amber, green, blue and white.

This tiny indicator lamp should find many applications in miniature apparatus and wherever space is very restricted. Despite its small size it throws quite a wide angle beam of light. As the fitting is too small to take any kind of tags or connecting lugs two different coloured insulated wires are brought out from the back and protected where they emerge from the body of the fitting by a flexible rubber sleeve.

Special small lamps only can be used and either the Hivac miniature with lilliput screw cap or an equivalent made by Vitality Bulbs will fit it. The maximum working voltage is 24, but normally lamps of 4 to 6 volts will be used.

"Anti-Tracking" Grease

THE water-repellent properties of silicone compounds, their good dielectric properties and the stability of their physical properties under extreme climatic conditions have been exploited in the formulation of special greases for weather proofing the ignition systems of aircraft and vehicles. Developed originally in America by the Dow Corning Corporation, silicone compound DC4, as it is called, is proving useful in the manufacture and servicing of television receivers, where it is applied as a surface treatment to maintain resistivity in e.h.t. circuits. Points where it is most effective include the area of glass adjacent to the anode cap of the c.r. tube, and the ends of e.h.t. rectifiers after soldering the connection.

Supplies are now available in this country, in 2-oz collapsible tubes with nozzle, from Direct T/V Replacements, 134-136, Lewisham Way, New Cross, London, S.E.14; the price is 10s or 10s 6d by post.

SOUND'S GOOD!

Sound amplification is only as good as the equipment can make it. Through TRIX installations it *always* sounds good—for TRIX have pioneered the development of equipment for faithful reproduction and equally faithful service. Ask for specifications of our exceptionally wide range of amplifiers and accessories.

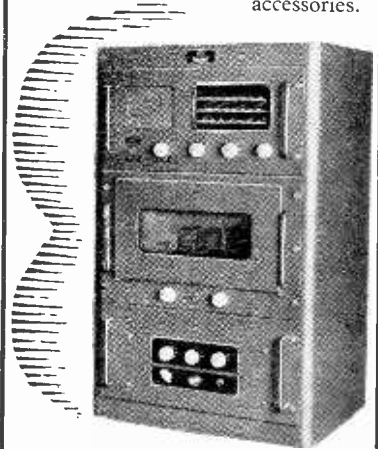

Enclosed rack-type Radio-Amplifier equipment, Model RGA 3/633. Combines amplifier with radio and 3 speed record changer.

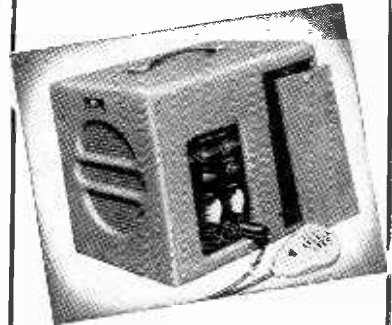

This TRIX Portable Battery equipment, B65, is unique, being self-contained with amplifier, speaker, 6v accumulator and microphone.

TRIX

The TRIX ELECTRICAL Co. Ltd.

Maple Place, Tottenham Court Road
London. W.1. MUSEum 5817

Telegrams: Trixadio Wesdo London.

RANDOM RADIATIONS

By "DIALLIST"

It's Easy, or Is It?

I BOUGHT a couple of 3-pin 5-amp switched sockets a short time ago with the firm intention of purging the wiring system of my house of its last remaining 2-pin sockets. I had fortunately not found time to do this when the switch of the three-pin socket from which the domestic receiver derives its power recently failed. With two spares to choose from, I thought the job of getting the wireless set going again wouldn't take a jiffy. No need to switch off the lights, for the circuit had its own fuses on the mains side of the socket. It was *easy* . . . or was it? Read on.

The Master Touch

Every now and then, I think, some designer of the bits and pieces that we use arrives at his office seething with resentment of some real or fancied wrong, and filled with fierce hatred of his fellow men. "I'll make 'em sit up," he mutters, going over to his drawing board. He then fills in certain details of the drawing of a component. When he has done, he has produced something bang up to the specifications of the B.S.I., the R.I.C. and other strict bodies. Electrically it is first rate. But with devilish ingenuity he has introduced one feature which will ensure that many a man will tear his hair when he comes to tackle the job of making connections to it or of fixing it in position. You've met that sort of component? I thought so! Well, these switched sockets were fine examples of what the disgruntled designer *can* do. No difficulty about fixing the leads; that was soon done. Nothing remained but to mount the chosen socket on its block. Simple enough: just a couple of 1½-in screws through the vitreous body. I'd plenty of No. 8's of the right length; but the largest screws that the holes would take were a bare ¼-in diameter. I had nothing of that size anywhere near long enough. Would you have had? Would any ordinary person? One thing that any socket needs is to be firmly and securely fixed in place with screws that get a good grip of the wood; perhaps the designer wanted two strings to his bow. Some of his victims might have had the necessary long, thin screws; but

there'd be plenty of fun later when someone wrenched the socket from its moorings!

Frame Aerials

THE ARTICLE on frame aerials by G. Bramslev in the November issue and the consequent correspondence have been of considerable interest to me. I live, you see, at a place where interference of various kinds is so severe that, with capacitative aerials, long-wave reception isn't worth while. Now, you may have discovered that the Paris-Inter programmes (mainly musical) on the long waves put down a strong signal with good quality—or, rather, they would do so if it weren't for interference. Some time ago I tried using a frame and found at once that a signal/noise level of the right kind could be obtained. I find a frame very useful, too, for the reception after dark of some m.w. stations which, with an outdoor aerial, fade badly through the interaction of ground- and sky-waves. As R. A. W. Hill pointed out last month, a frame which can be tilted as well as turned in azimuth is a great help.

More Trouble at "Okey"

Writing from a village near Okehampton, a reader tells me that it is now almost impossible in his neigh-

bourhood to obtain reasonably good reception of the West Regional programme. I referred some months ago to the trouble that had followed the inauguration of the booster transmitter at Fremington, which relays Start Point. In some parts of Devon the two sets of waves interact so severely (now that the output power of Fremington has been increased) that violent, rapid fading ruins reception. Isn't this an instance when a frame might be of use? I suggest to my correspondent that he should give it a trial and see whether he can't make use of its directional properties to reject one or other of the transmissions.

Coronation Television

IT SEEMS A PITY that the Powers that Be cannot see their way to sanctioning more temporary extensions of the television service. The transmitters at Pontop Pike and Belfast will bring so much pleasure and such lasting memories to so many people in the areas they are to serve. One cannot help regretting that dwellers in the other areas eventually to be served by the other three low-power transmitters won't be as fortunate; still, if the national resources really won't stand the strain, I suppose that those affected must just grin and bear it. We have all had by now a pretty good training in putting up with the far-from-sweet fruits of victory, a fact which any who accuse us of warmongering might do well to realize! All the same, it would not surprise me enormously if the authorities came to modify to some extent their stern attitude to-



"WIRELESS WORLD" PUBLICATIONS

	Net Price	By Post
RADIO INTERFERENCE SUPPRESSION as Applied to Radio and Television Reception. G. L. Stephens, A.M.I.E.E.	10/6	10/11
RADIO VALVE DATA : Characteristics of 2,000 Receiving Valves and C.R. Tubes. Compiled by the Staff of "Wireless World." 3rd Edition	3/6	3/9
SOUND RECORDING AND REPRODUCTION. J. W. Godfrey and S. W. Amos, B.Sc., A.M.I.E.E., in collaboration with the B.B.C. Engineering Division	30/-	30/8
MICROPHONES. By the Staff of the Engineering Training Dept. B.B.C.	15/-	15/5
ADVANCED THEORY OF WAVEGUIDES. L. Lewin.	30/-	30/7
FOUNDATIONS OF WIRELESS. M. G. Scroggie, B.Sc., M.I.E.E. 5th Edition	12/6	13/-
TELEVISION RECEIVING EQUIPMENT. W. T. Cocking, M.I.E.E. 3rd Edition	18/-	18/8
SHORT-WAVE RADIO AND THE IONOSPHERE. T. W. Bennington. 2nd Edition	10/6	10/10
WIRELESS SERVICING MANUAL. W. T. Cocking, M.I.E.E. 8th Edition	12/6	12/11
BASIC MATHEMATICS FOR RADIO STUDENTS. F. M. Colebrook, B.Sc., D.I.C., A.C.G.I. 2nd Edition	10/6	10/10

A complete list of books is available on application.

Obtainable from all leading booksellers or from

ILIFFE & SONS LTD., Dorset House, Stamford Street, London, S.E.1.

wards Coronation expansions of the television service. I understand that steps are being taken to try and convince the Government that the thing can be done quite painlessly and without any drain on our essential resources.

On the Continent

If, as seems likely, Radiodiffusion et Télévision Françaises decides to take the B.B.C.'s television transmission of the Coronation, viewers living in many European countries may be able to watch the processions to and from Westminster Abbey as well as the ceremony itself. Last summer's Franco-British television exchange showed convincingly that conversion from one standard to another was a practical proposition. In that instance it called for a conversion from the 819-line standard to a 405-line picture for this country and a 441-line picture for some French viewers. The process will have to be reversed for the Coronation transmissions. It remains to be seen whether the French engineers are able to resolve this difficulty. If so, there is no good reason why countries with 625-line systems should not be able to come to an arrangement with the French authorities for making the necessary conversion to their own standard.

Getting Them Going

The Coronation might actually be the means of getting television really under way in many European countries. The present position in Belgium, Holland, Denmark, Sweden and Italy is not unlike what it was in this country in the years just before the war. There are television services (for which, by the way, our manufacturers have supplied and continue to supply much of the equipment) covering some of the more densely populated areas. Public interest in television is enormous—but shows itself mainly in flocking to exhibitions and demonstrations. As with us before September, 1939, when the outbreak of war closed television down, people will do anything to prove their desire for television *except* buy sets! A statement on chemical lines of the existing vicious circle on the Continent might be

Poor sales of sets	}	→	Limited hours of transmission and poor programmes
			←

Once the ball starts rolling it rapidly gathers momentum, as we and the Americans have seen. But it takes something to get the ball started.

PUT YOUR TRUST IN BULGIN COMPONENTS

RELIABILITY is the keynote of Bulgin Components. Only the finest-grade materials are used, and workmanship is to the highest standards and specifications.

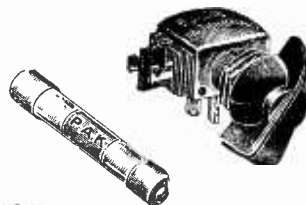

EVERY COMPONENT is routine and type tested, using scientifically devised methods of test and inspection, with the most up-to-date equipment.

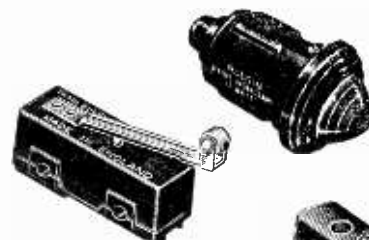

THE RANGE OF Components is VAST, and caters for the professional and also the amateur radio enthusiast and experimenter. New and improved models are continually being added to the range

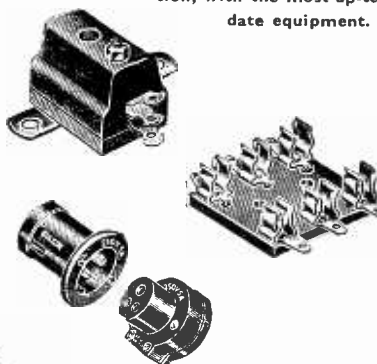

BULGIN COMPONENTS, famous since broadcasting began, are in constant demand in all four corners of the earth. Put your trust in Bulgin Components.

Send for New Catalogue (Ref. 191/WW).
Price 1/-, post free.

A. F. BULGIN & CO. LTD.

MANUFACTURERS OF RADIO & ELECTRONIC COMPONENTS

BYE-PASS ROAD, BARKING, ESSEX

Telephone: RIPPleway 3474 (6 lines)

UNBIASED

By FREE GRID

Adding "Ionic" to Mr. Therm

IN my ignorance I have always supposed the ugly structure which is popularly called a gasometer, but is more correctly termed a gas holder, to be the perfect screening can, only equalled by a submerged submarine. Indeed, I recollect the Editor telling me, in the days of 2LO, of the reception difficulties experienced by a W.W. reader who lived among the gas holders hard by King's Cross station and had slung his aerial between two of them. It was not surprising that he failed to get 2LO although only about a couple of miles from the transmitter in Oxford Street.

However, modern techniques, and in particular v.h.f., have changed all that and it is now as easy to pick up a transmission when you are actually inside a gas holder as it would be on the top of the Nelson Column. It is, in fact, so easy to transmit and receive when inside a gas holder that, according to an article by a gas engineer in the January issue of the *Short Wave Listener*, when men were inside cleaning one out last summer they were provided with v.h.f. apparatus to enable them to keep in touch with their fellow workers outside.

Wireless Acheel

I HAVE little doubt that a shrill ringing of bells and a howl of execration will go up from the wobbly ranks of those who ride bicycles when I say that their habit of riding two abreast so that they can indulge in ceaseless chatter makes them the most dangerous of all users of the road. They not infrequently keep to the crown of the road while a crowd of smoke-choked motorists, who are fuming in more senses than one, trail behind them.

I was confronted with this problem in the case of my own family and have proved that there is not the slightest reason for this riding abreast in order to carry on a conversation. That was, of course, in the days before we were overwhelmed by the present deluge of car dealers all beseeching us with tears in their eyes to take delivery of the automobiles we ordered years ago.

Needless to say, I found radio to be the solution of my problem and I soon had the whole family pedalling along in line astern and exchanging the usual conversational inanities. This enabled us to use the highway without causing offence to those patriotic "essential users" of new cars who honked their way imperiously along the Brighton Road every week-end, bent earnestly on the nation's business, during the "seven lean years" when new cars were quite rightly denied to us selfish pleasure-seekers. Since the required radio range was only a few feet, each of my "receivermitters" was almost as small as a couple of hearing aids, and was, in fact, a miniature "Walkie-talkie" and might, I suppose, have been named a "Bikie-Mikie" or something equally fatuous.

Calling All Cars

UNDOUBTEDLY one of the most successful applications of wireless is its use by the police to link up patrol cars with H.Q., which in the case of the Metropolitan Police is, of course, Scotland Yard. Had I been asked I should have said that police wireless started with wireless telegraphy and later graduated to the present system of telephony, but I should have been quite wrong.

There is no evidence so reliable or so readily accepted in court as that written down in a policeman's notebook and according to what I recently read in one of them the police started by using telephony at the beginning of the 'twenties. However, in view of the comparatively crude state of technique in those days it is not surprising to learn that they soon abandoned it in favour of telegraphy, although they have long since returned to telephony.

The particular "policeman's notebook" I have been reading is actually a book of reminiscences, "Hambrook of the Yard," by ex-Detective-Superintendent Hambrook which I picked up from a second-hand book-stall while the superintendent's successors were not looking. With

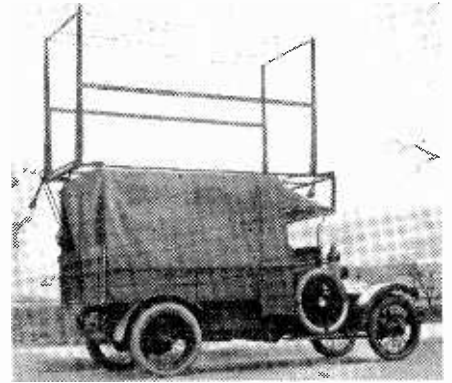

The Flying Squad, 1920.

acknowledgments to whomsoever they are due,* I have taken the opportunity of filching a photograph from the superintendent's book of one of the two first police cars with its retractable "bedstead" aerial.

* Published in 1937 by Robert Hale & Co.

Ouida Up-to-date

I WONDER how many of you have read any of the novels, so beloved of a bygone generation, of the good lady who wrote under the name of "Ouida" and whose statue stands in the ancient city of Bury St. Edmunds. She always wrote a first-rate story but was a little apt to let herself get so carried away by the good qualities of her heroes that she credited them with the ability to perform superhuman feats. Her most famous effort occurred when describing the boat race. Her hero was in the Oxford boat, and to continue in her own words "All rowed fast, but none so fast as he."

I am reminded of this by a recent letter to the editor of one of our more sober Sabbath journals in which the writer credits the high notes of the musical spectrum with similar qualities to those of Ouida's boat-race hero; in other words, they don't keep in step with the lower notes but actually travel more rapidly. If this be so it explains a lot of things that have hitherto puzzled me.

It certainly explains why the strident screechings of sopranos have such a devastating effect on me. It is because their top notes reach my ears first, unaccompanied by any more basic sounds which would tend to tone them down.

